

Shock Absorber



Shock Absorber



Factory Over View

Location	28, Mtv 4-Ro 48Beon-Gil, Danwon-Gu. Ansan-Si, Gyeonggi-Do, 15658, KOREA
Website	http://www.kicoltd.co.kr
E-mail	kicoltd@kicoltd.co.kr
TEL	+82-31-432-4081~3
FAX	+82-31-624-4086
Business field	All about Shock absorber Manufacturing and supplying Shock Absorber
The Ground Space	5,000 m ²
Building & Layer	2 buildings & 4 floors
Max Height	17.80 m
Building Area	3,740.45 m ²
Gross Floor Area	6,558.71 m ²

CONTENTS

13	HYUNDAI
26	KIA
36	DAEWOO/GM/CHEVROLET
43	RENAULT SAMSUNG
44	SSANGYONG
45	TOYOTA-LEXUS
52	NISSAN
54	SUZUKI
55	MITSUBISHI
56	MAZDA
58	ISUZU
59	CHERY
60	BYD
61	GEELY
62	FIAT
63	CHRYSLER
64	OPEL
65	PEUGEOT
66	COMPATIBLE NO LIST



KIC History

- 1998** KOREA INTER CROSS Co., Ltd Found
"Technical Concentrated Small & Medium Co." Certification
- 1999** "One million Dollar Export Tower" awarded
"Prize of Prime minister" awarded
- 2001** Sihwa KIC Head office & main factory completion & relocation
- 2002** Technical Assistance to IRAN "KSV KHODRO Co." for SAIPA & KHODRO
- 2005** "USD Five million Dollar Export Tower" awarded
Awarded "Stone Pagoda Industrial Medal" by the President
- 2007** HYUNDAI MOTORS CO. Tuning Shock Absorber Cooperator Contract
- 2008** Russia [TagAZ Motors Co.] S/ABS Supply Contract
- 2009** Start Shock Absorber Business in After Market
- 2011** Awarded Prize of Minister of Knowledge Economy
- 2014** Increase the application of the global car models and parts specs
- 2015** Ansan MTV KIC Head office & Main factory relocation
- 2017** Awarded by achieving \$ 100 million export accumulated
- 2018** Expected to attain "Ten million Dollar Export Tower" awarded.
- 2019** Selected as "Small Giant Company of Korea"
Selected as "Great Work Place for Root Company"

Shock Absorber Structure

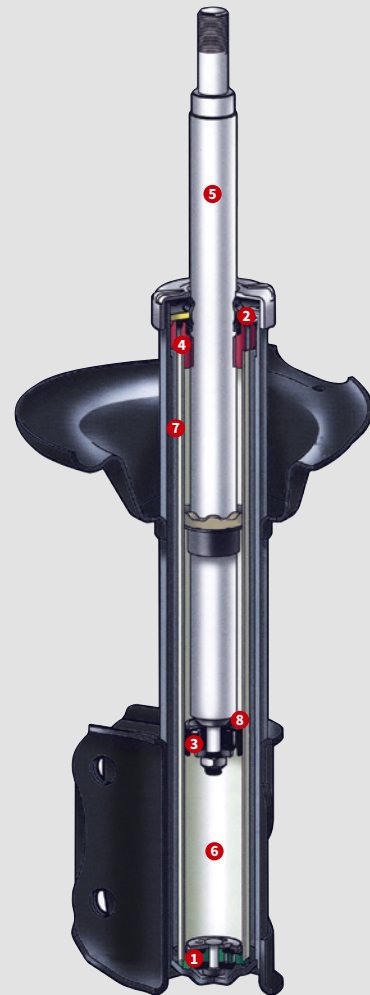

Suspension Struct

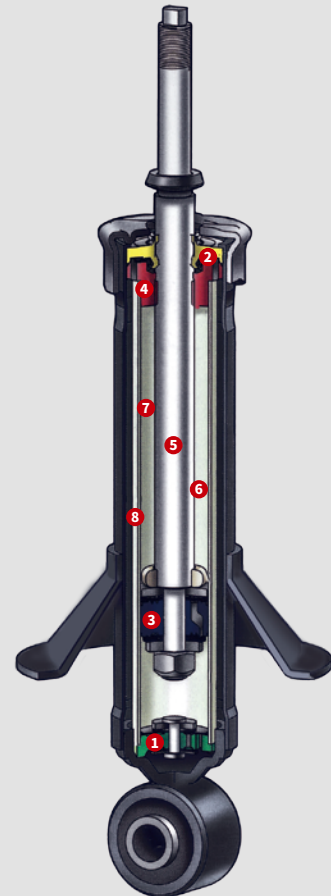

Semi Struct

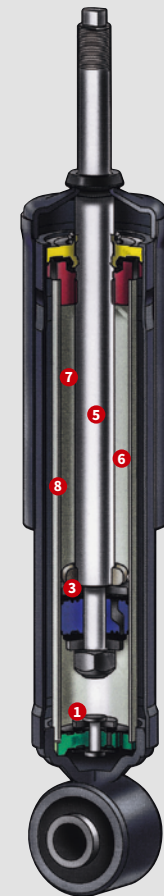

Conventional Shock Absorber

① BOTTOM VALVE

KIC compression disc valve, which provides excellent performance, has automatic control actions similar to the rebound piston disc valve.

② OIL SEAL

The special oil seal, made of oil and wear resistant high quality synthetic rubber, having high sealing efficiency to keep vital oil and gas in and dirt out of the cylinder.

③ PISTON VALVE

KIC unique automatic control rebound disc valve, which automatically adjusts to all ride conditions, is designed to assure maximum performance and smooth ride control. It also provides instant response for full performance without any time lag.

④ ROD GUIDE

The sintered iron rod guide with a PTFE bushed sliding surface assures smooth rod action with minimal resistance and wear.

⑤ PISTON - ROD

The piston-rod, larger in diameter to increase the strength, is hard chrome plate, induction hardening, and fine polished for greater resistance to corrosion, thus, assuring of smooth action.

⑥ SHOCK ABSORBER OIL

KIC shock absorber oil with constant viscosity, blended with chemical additives provide optimum operating performance keeping its efficiency, in any weather conditions.

⑦ NITROGEN GAS

Nitrogen gas is filled in the reservoir.

⑧ CYLINDER TUBE

The cylinder tube, with a precision sliding surface mirror-like finish is designed to withstand tremendous internal working pressures, thus, providing greater reliability.

How to Install Shocks

When replacing shock absorbers, please select the correct shocks from the application listing, and follow the instructions below.

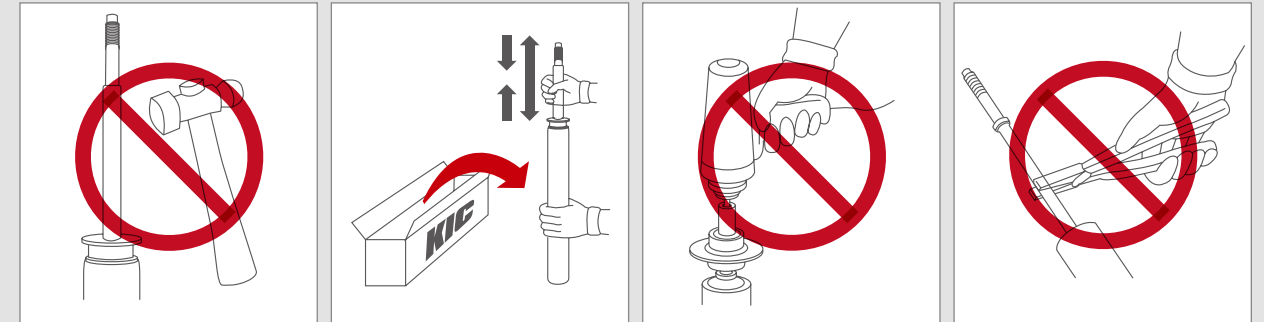

01. When removing the used shock absorbers

- ▶ Please check and remember the positions where each of the parts are currently installed. After installing new shocks, the fittings must be set back in the original position.
- ▶ Please remove dirt and rust from screws by using a stiff brush.
- ▶ Before removing the screws, please make sure to apply oil on to the rusted nuts & screws. If you tap delicately with a hammer, the oil will easily soak into the grooves.
- ▶ Please do not throw away the worn shock and the removed kits until installation of the new shocks is completed.

02. When installing the new shock absorbers

- ▶ Before installation, please check the KIC number on the shock body, and compare it with the application listing, making sure the model year and fitting position, etc., are correct.
- ▶ Please confirm that all the parts required for installation are included in the product package.
- ▶ Please use after shaking up and down 5-10 times, when any problem in pressure occurs.
- ▶ Please do not grab the piston rod, or damage it, with any type of metallic tool. Damaging a piston rod will ruin the rod seal, causing leakage.
- ▶ When installing the "eye type", please do not tighten the nut when the car body is jacked up. please tighten the nut in the natural position.
- ▶ In case of the bolt type, please follow the diagram printed on the plastic bag for the fitting kits or the mounting-kit listing.
- ▶ When installing a cartridge, please follow this procedure:
 - Remove the strut from the car body.
 - Remove the gland nut and take the internal parts out of the strut housing.
 - Remove the oil in the strut housing and clean the internal surfaces.
 - Insert the new cartridge into the strut housing.
 - Use the new gland nut contained in the box to fix the cartridge securely in place.
- ▶ Make sure that all nuts and bolts are tightened securely.

03. When scrapping the used shock absorbers

- ▶ Please take out the oil completely.
- ▶ For gas shocks, please take out the gas and oil completely.
- ▶ Follow your local regulation when throwing away old shock absorbers.

How to Install Shocks

When replacing shock absorbers, please select the correct shocks from the application listing, and follow the instructions below.

THREAD BROKEN OFF AT THE TOP OF PISTON ROD

Cause

- ▶ Tightened with impact wrench

Prohibitions

- ▶ Impact Wrench can make Torque higher than the recommended limit.

Countermeasure

- ▶ Do not use any power tools.

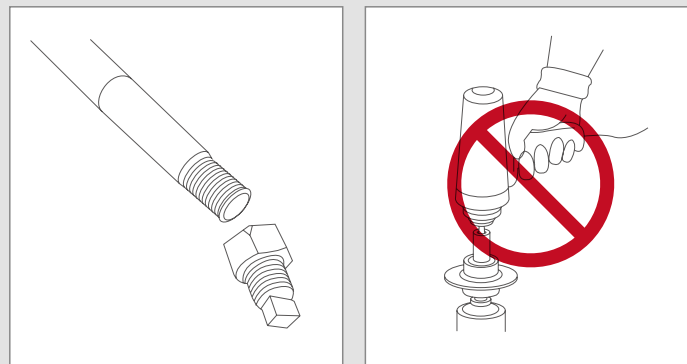

BROKEN SEAL PARTS / OIL LEAKAGE / GAS LEAKAGE

How to avoid the above mistake (Correct Installation of a nut on a piston rod)

- ▶ To hold a shock absorber (Outer shell) with vice system.
- ▶ To put "L bar wrench(T bar wrench)" on top of piston rod in order to fix a piston rod.
- ▶ To screw a nut with an open end wrench.

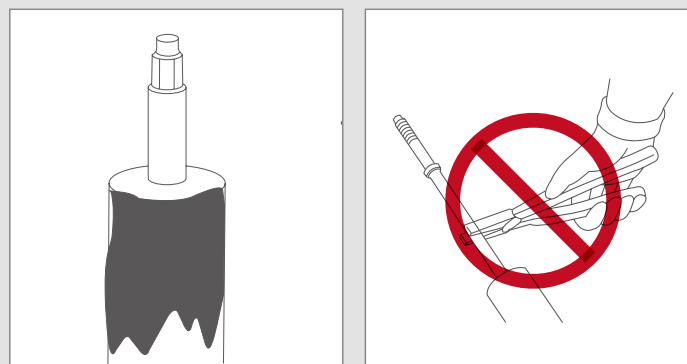

Prohibitions

- ▶ To grip a piston rod with any tools(plier, etc) may harm the surface of a piston rod.
- ▶ Its damage will break seal parts in shock absorber.
- ▶ Then oil leakage, gas leakage etc will happen.

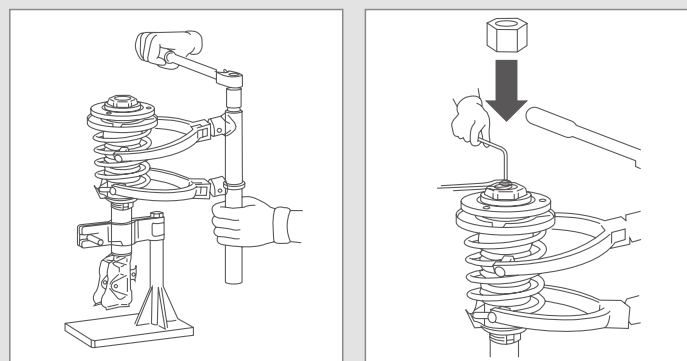

Oil Leakage

Normally Oil Leakage occurs due to "damaged oil seal or Bushing" Any damage to piston rod affects oil seal and bushing. Please check following points and investigate why the piston rod has been damaged according to the condition of it.

01.

Chrome peeled off on a piston rod

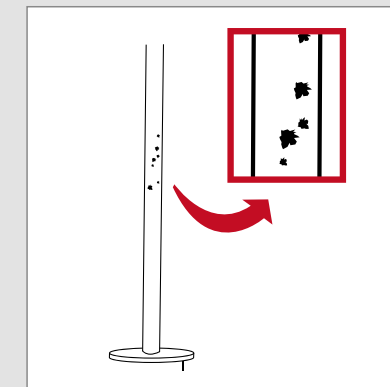

Cause

Damage due to worn out parts (Dust Cover, Bump Rubber)

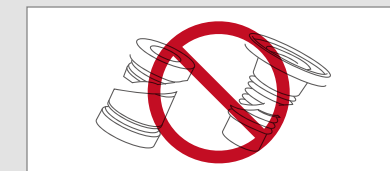

Countermeasure

Replace those parts with New Parts, and replace new KIC shock absorber

02.

Damage on surface of piston rod as in photo

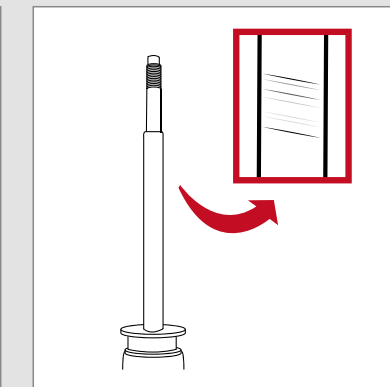

Cause

Damage by tools(plier,etc) during installation of Shock Absorber



Countermeasure

Do not hold a piston rod by any tools Replace now KIC shock absorber

03.

Damage on one side of a surface of piston rod as in photo.

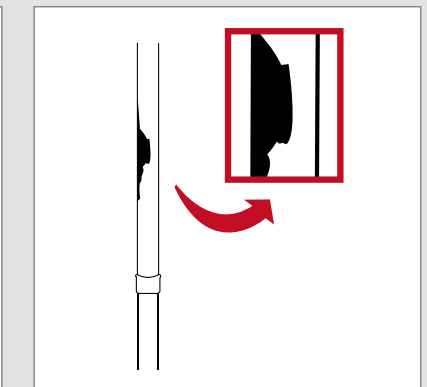

Cause

Unsatisfactory installation of shock absorber causes irregularity.

Example

- 1) Loose Tightening of a rod nut
- 2) Failure of process of parts

Countermeasure

Correct Installation with the right instruction of suitable tools.

SHOCK ABSORBER REPLACEMENT CRITERIA

STRUT TYPE	LEVEL 5	LEVEL 4	LEVEL 3	LEVEL 2	LEVEL 1
OIL LEAK CRITERIA ① OIL SEAL CASE ② SPRING SEAT ③ KNUCKLE BRACKET					
CONDITION	Slight oil seepage from oil seal case	Moderate oil seepage from oil seal case	Oil leak/drip on the seal case, extending below the spring seat	Oil leak, covering top, spring seat, and part of strut body	Oil leak, covering entire strut body, spring seat, and knuckle bracket
ACTION	Normal oil evaporation Not necessary to replace the shock absorber	Normal oil evaporation Not necessary to replace the shock absorber	Abnormal oil leak Replace the shock absorber	Abnormal oil leak Replace the shock absorber	Abnormal oil leak Replace the shock absorber

HYUNDAI



Shock Absorber

KIC Factory NO. Designation



- | | | |
|------------------------------|----------------------------|----------------------------|
| 1 KIC | K: KIA | 4 SERIAL NUMBER |
| 2 NATION | M: MAZDA | 5 F: FRONT |
| C: CHINA | MI: MITSUBISHI | R: REAR |
| F: FRANCE | N: NISSAN | 6 L: LH |
| G: GERMANY | R: RENALT & SAMSUNG | R: RH |
| J: JAPAN | S: SSANGYONG | C: L/R (Common use) |
| S SOUTH KOREA | T: TOYOTA | 7 O: OIL TYPE |
| U: USA | CH : Chevrolet | G: GAS TYPE |
| 3 BRAND | D : DAEWOO GM | |
| B : BYD | F : FIAT | |
| C: CHERY | G : GEELY | |
| D: DAEWOO & Chevrolet | I : ISUZU | |
| H: HYUNDAI | L : TOYOTA-LEXUS | |
| H: HONDA | P : PEUGEOT | |

CAR NAME	FRONT							REAR						
	LH/RH/CM	GAS/OIL	TYPE	KIC FAC_NO	OE NO	KYB NO	REMARK	LH/RH/CM	GAS/OIL	TYPE	KIC FAC_NO	OE NO	KYB NO	REMARK
ATOZ MX														
97/09-02/12	LH	OIL	S	KSH-007FLO	54650-02000	633205		CM	OIL	C	KSH-007RCO	55310-02000	443300	E-E EON(CM) (ONLY RR)
					54650-02020	333257(GAS)						55310-02010	343301(GAS)	
					54650-02021							55310-02011		
					54650-02100							55310-02110		
					54650-02120									
					54650-02121									
					54650-02210									
					54650-02220									
					54650-02221									
					54650-02310									
					54650-02320									
					54650-02321									
					54650-02410									
					54650-02420									
					54650-02421									
					54650-02510									
					54650-02520									
	RH	OIL	S	KSH-007FRO	54660-02000	633204								
					54660-02020	333256(GAS)								
					54660-02021									
					54660-02100									
					54660-02120									
					54660-02121									
					54660-02210									
					54660-02220									
					54660-02221									
					54660-02310									
					54660-02320									
					54660-02321									
					54660-02410									
					54660-02420									
					54660-02421									
					54660-02510									
					54660-02520									
ACCENT X3														
94-99	LH	OIL	S	KSH-001FLO	54650-22000	633178		LH	OIL	S	KSH-003RLO	55350-22000	632104	
					54651-22000	333212(GAS)						55351-22000	332081(GAS)	
					54651-22100							55351-22050		
					54651-22102							55351-22051		
					54651-22200							55351-22100		
					54651-22201							55351-22150		
					54651-22300							55351-22151		
					54651-22350							55351-22200		
					54651-22450							55351-22250		
					54651-22900							55351-22300		
					54651-22901							55351-22350		
					54651-22902							55351-22400		
					54651-22950							55351-22450		
					54651-22951							55351-22500		
					54651-22952							55351-22600		
												55351-22650		
												55351-22900		
												55351-22901		
												55351-22950		
												55351-22951		





HYUNDAI
KIA
DAEWOO GM CHEVROLET
RENAULT SAMSUNG
SSANGYONG
TOYOTA LEXUS
NISSAN
SUZUKI
MITSUBISHI
MAZDA
ISUZU
CHERY
BYD
GEELY
FIAT
CHRYSLER
OPEL
PEUGEOT

HYUNDAI

CAR NAME	FRONT							REAR						
	LH/RH/CM	GAS/OIL	TYPE	KIC FAC_NO	OE NO	KYB NO	REMARK	LH/RH/CM	GAS/OIL	TYPE	KIC FAC_NO	OE NO	KYB NO	REMARK
AVANTE MD														
10-13 ELANTRA MD 	LH	GAS	S	KSH-009FLG	54651-3X000	333519		CM	GAS	C	KSH-009RCG	55300-3X000	349184	E-E
					54651-3X050	3330049						55300-3X100		
					54651-3X051	G7404(MONROE)						55300-3X110		
					54651-3X150							55300-3X150		
					54651-3X151							55300-3X200		
					54651-3X160							55300-3X210		
					54651-3X250							55300-3X220		
					54651-3X251							55300-3X400		
					54651-3X260							55300-A5700		
					54651-3X350							55310-3X200		
					54651-3X351									
					54651-3X360									
		RH	GAS	S	KSH-009FRG	54661-3X050	333518							
						54661-3X051	3330048							
						54661-3X150	G7403(MONROE)							
						54661-3X151								
						54661-3X160								
						54661-3X250								
					54661-3X251									
					54661-3X260									
					54661-3X350									
					54661-3X351									
AVANTE AD														
15-18 ELANTRA AD 	LH	GAS	S	KSH-048FLG	54651-F2000			CM	GAS	C	KSH-048RCG	55310-F2000		R-E
					54651-F2010							55307F2520		
					54651-F2020							55310-F2500		
					54651-F2500							55310-F2710		
					54651-F2510									
					54651-F2BA0									
		RH	GAS	S	KSH-048FRG	54661-F2000								
						54661-F2010								
						54661-F2020								
						54661-F2500								
					54661-F2510									
					54661-F2BA0									
ACCENT HC														
18- 	LH	GAS	S	KSH-061FLG	54650-H6200			CM	GAS	C	KSH-061RCG	55310-H6200		
	RH	GAS	S	KSH-061FRG	54660-H6200									
CLICK TB														
02-11 GETS 	LH	GAS	S	KSH-012FLG	54650-1C000	333507		CM	GAS	C	KSH-012RCG	55310-1C000	343398	R-E
					54650-1C050							55310-1C200		
					54650-1C100							55310-1C500		
					54650-1C150									
					54650-1C200									
					54650-1C300									
		RH	GAS	S	KSH-012FRG	54660-1C000	333506							
						54660-1C050								
					54660-1C100									
					54660-1C150									
					54660-1C200									
					54660-1C300									

HYUNDAI

CAR NAME	FRONT							REAR						
	LH/RH/CM	GAS/OIL	TYPE	KIC FAC_NO	OE NO	KYB NO	REMARK	LH/RH/CM	GAS/OIL	TYPE	KIC FAC_NO	OE NO	KYB NO	REMARK
CRETA GS														
14- IX25 	LH	GAS	S	KSH-037FLG	54650-C9000			CM	GAS	C	KSH-037RCG	55300-C9000	3440071	R-E
					54650-C9100							55310-C9000		
					54651-A0100							55310-A0000		
					54651-A1000							55310-M0000		
					54651-M0000									
		RH	GAS	S	KSH-037FRG	54660-C9000								
						54660-C9100								
						54661-A0100								
						54661-A1000								
						54661-M0000								
CHORUS 94-MY														
94.12-98.03 	CM	OIL	C	KSH-057FCO	54300-46050		R-E							
EXCEL X2														
85-94 PONY 	CM	OIL	S	KSH-015FCO	54650-24000	633150		CM	OIL	C	KSH-015RCO	55310-24000	443269	E-E
					54650-24110	333156(GAS)						55310-24152	343183(GAS)	
					54650-24120							55310-24400		
					54650-24300							55310-24450		
					54650-24400							55310-24452		
ELANTRA J1														
90-95 LANTRA 	CM	OIL	S	KSH-014FCO	54650-28012	634050		CM	OIL	S-S	KSH-014RCO	55310-28000	441091	S-E
					54650-28102							55310-28011		
					54650-28202							55310-28100		
					54650-28221							55310-28101		
					54650-28201							55310-28202		
												55310-28221		
		GAS	S	KSH-014FCG	54650-28512	334088		GAS	S-S	KSH-014RCG	55310-28510	341147		
					54650-28511							55310-28512		
					54650-28521							55310-28521		
												55310-28600		
EON HA														
12- 	LH	GAS	S	KSH-038FLG	54650-4N000		DCUT-<2011.08	CM	GAS	C	KSH-038RCG	55300-4N000		E-E
					54650-4N050		DCUT X 2011.08->							ATOZ(ICM)
		RH	GAS	S	KSH-038FRG	54660-4N000		DCUT-<2011.08						
					54660-4N050		DCUT X 2011.08->							
GRACE H100														
86-03 PORTER_AU (CM) 	CM	OIL	C	KSH-016FCO	54300-43000	444128	R-E	CM	OIL	C	KSH-016RCO	55300-43000	444023	E-E
					54300-43003							55300-43100	344102(GAS)	
					54300-43100							55300-43150		
					54300-43102							55300-43430		
					54300-43160							55300-43431		
					54300-43450							55300-43440		
					54300-43470							55300-43650		
					54300-43650									
GALLOPER M100														
91-03 =Pajero(82-03) 	CM	GAS	C	KSH-050FCG	54310-M1060		R-E(X PIN)	CM	GAS	C	KSH-050RCG	55310-M1400		E-E (91-97) LONG
					54310-M1070							HB227600		
					54300-M1070									
					HB217300									
					HB217200									
		OIL	C	KSH-050FCO	54310-M1050				OIL	C	KSH-050RCO	55310-M1200		

HYUNDAI

CAR NAME	FRONT							REAR						
	LH/RH/CM	GAS/OIL	TYPE	KIC FAC_NO	OE NO	KYB NO	REMARK	LH/RH/CM	GAS/OIL	TYPE	KIC FAC_NO	OE NO	KYB NO	REMARK
GALLOPER M160														
									GAS	C	KSH-051RCG	55310-M1600	344116	E-E (97-03)
												55300-M1600	554068	
												HB227400		
GRANDEUR XG														
98-05 SONATA EF(CM)	CM	GAS	S-S	KSH-006FCG	54611-39400	341280	S-C	CM	GAS	S-S	KSH-006RCG	55311-38500	341246	S-E
					54611-39401	341245		98-02				55311-39000	341427	
					54611-39402							55311-39400		
					54611-39403							55311-39501		
					54611-39404									
					54611-39410									S/S UP EF_SONATA (CM)
					54611-39502									
					54611-39504									
					54611-39700									
GRANDEUR XG 02-MY														
	CM	GAS	S-S	KSH-006-1RCG	55311-38601	341281	S-E							
								02-05				55311-38610		
														S/S LW NEW EF SONATA (CM) OPTIMA (CM) SONATA (CM)
GRANDEUR TG														
05-11 SONATA NF (CM) AZERA	CM	GAS	S-S	KSH-029FCG	54611-3L020	341476	S-C	CM	GAS	C	KSH-029RCG	55311-3L021	349060	R-E
					54611-3L021							55311-3L030		
					54611-3L030							55311-3L130		
					54611-3L640							55311-3L630		
					54611-3L770							55311-3L640		
												55311-3L770		
GRANDEUR HG														
11-17 3.0L	LH	GAS	S	KSH-030FLG	54651-3V010			CM	GAS	C	KSH-030RCG	55311-3V010		R-F
					54651-3V110							55311-3V050		
					54651-3V210							55311-3V080		
												55311-3V500		
	RH	GAS	S	KSH-030FRG	54661-3V010									
					54661-3V110									
					54661-3V210									
HG (EX)	LH	GAS	S	KSH-031FLG	54651-3V410									
12.04-2.4L														
	RH	GAS	S	KSH-031FRG	54661-3V410									
					54661-3V281									
HG (SX)	LH	GAS	S	KSH-031FLG-16	54651-3V281									
12.04-2.4L					54651-3V500									
	RH	GAS	S	KSH-031FRG-16	54661-3V281									
					54661-3V500									
110 PA														
07-13 MORNING_SA (CM)	LH	GAS	S	KSH-018FLG	54650-0X000	332503		CM	GAS	C	KSH-018RCG	55300-0X000	349087	E-E
					54650-0X100							55300-0X100		
					54650-0X200							55300-0X200		
					54650-1X100									
	RH	GAS	S	KSH-018FRG	54660-0X000	332502								
					54660-0X100									
					54660-0X200									
					54660-1X100									

HYUNDAI

CAR NAME	FRONT							REAR							
	LH/RH/CM	GAS/OIL	TYPE	KIC FAC_NO	OE NO	KYB NO	REMARK	LH/RH/CM	GAS/OIL	TYPE	KIC FAC_NO	OE NO	KYB NO	REMARK	
GRAND I10 BA															
13-	LH	GAS	S	KSH-035FLG	54650-B4000				CM	GAS	C	KSH-035RCG	55310-B4050	3430039	R-E
					54650-B4050							55310-B4060			
					54650-B4100							55310-B4080			
					54650-B9000							55310-B4150			
	RH	GAS	S	KSH-035FRG	54660-B4000										
					54660-B4050										
					54660-B4100										
					54660-B9000										
I20 PB															
08-14	LH	GAS	S	KSH-034FLG-GED	54650-1J000				CM	GAS	C	KSH-034RCG	55300-1J000	349098	E-E
					KSH-034FLG-GE	54650-1J050						55300-1J200			
					KSH-034FLG-ID	54650-1J200						55310-1J000			
	RH	GAS	S	KSH-034FRG-GED	54660-1J000							55310-1J001			
					KSH-034FRG-GE	54660-1J050						55310-1J101			
					KSH-034FRG-ID	54660-1J200									
I20 GB															
12-15	LH	GAS	S	KSH-040FLG	546504-P500										
					54650-1J451										
	RH	GAS	S	KSH-040FRG	54660-4P500										
					54660-1J451										
I20 GB ACTIVE															
CROSS OVER MODEL	LH	GAS	S	KSH-036FLG	54650-C7000				CM	GAS	C	KSH-036RCG	55310-C7000		R-E
															
	RH	GAS	S	KSH-036FRG	54660-C7000										
I30 FD															
07-11 CEED 06 (CM)	LH	GAS	S	KSH-019FLG	54651-2L000	338025			CM	GAS	C	KSH-019RCG	55311-2L000	349084	R-F
					54651-2L100							55311-2L100			
					54651-2L101							55311-2L200			
					54651-2L200							55311-2L600			
					54651-2L201							55311-2R200			
					54651-2L600							55300-A6000			
												55300-A6050			
												55300-A6400			
	RH	GAS	S	KSH-019FRG	54661-2L000	338024									
					54661-2L100										
					54661-2L101										
					54661-2L200										
					54661-2L201										
					54661-2L600										
I30 FD CW															
07-11 CROSS WAGON CEED SW (CM)	LH	GAS	S	KSH-019FLG-CW	54650-2R100										
					54651-2R400										
					54651-2R450										
					54651-2R600										
ELANTRA TOURING					54651-2R700										
					54651-1H600										
	RH	GAS	S	KSH-019FRG-CW	54660-2R100										
					54661-2R400										
					54661-2R450										
					54661-2R600										
					54661-2R700										
					54661-1H600										

HYUNDAI
KIA
DAEWOO GM CHEVROLET
RENAULT SAMSUNG
SSANGYONG
TOYOTA LEXUS
NISSAN
SUZUKI
MITSUBISHI
MAZDA
ISUZU
CHERY
BYD
GEELY
FIAT
CHRYSLER
OPEL
PEUGEOT

HYUNDAI

CAR NAME	FRONT							REAR						
	LH/RH/CM	GAS/OIL	TYPE	KIC FAC_NO	OE NO	KYB NO	REMARK	LH/RH/CM	GAS/OIL	TYPE	KIC FAC_NO	OE NO	KYB NO	REMARK
I30 GD														
11-16 	LH	GAS	S	KSH-052FLG	54651-A5000			CM	GAS	C	KSH-052RCG	55300-A5000		E-E
	RH	GAS	S	KSH-052FRG	54661-A5000							55300-A5060		
LAVITA FC														
07-10 MATRIX 	LH	GAS	S	KSH-020FLG	54651-17100	333367		LH	GAS	S	KSH-020RLG	55351-17100	333505	
					54651-17200							55351-17200		
					54651-17250							55351-17230		
					54651-17500							55351-17500		
					54651-17600							55351-17600		
	RH	GAS	S	KSH-020FRG	54661-17100	333366		RH	GAS	S	KSH-020RRG	55361-17100	333504	
					54661-17200							55361-17200		
					54661-17500							55361-17500		
				54661-17600							55361-17600			
MIGHTY1 EF4 86-MY														
86-98 	CM	OIL	C	KSH-056FCO	54300-45006		R-E	CM	OIL	C	KSH-056RCO	55300-45002		E-E
MIGHTY 2														
KIA PAMAX(CM) HD65/HD72 	CM	OIL	C	KSH-053FCO	54300-5H000		R-E	CM	OIL	C	KSH-053RCO	55300-5H000		R-E
					54300-5H500							55300-5H500		
												55300-5H600		
PORTER AH														
86-97 PORTER 1 	CM	OIL	C	KSH-004FCO	54300-44150	444022	R-E(XPIN)	CM	OIL	C	KSH-004RCO	55300-44104	444151	E-E
PORTER AU														
96-04 NEW PORTER GRACE(CM) PORTER_HR(CM) 	CM	OIL	C	KSH-005FCO	54300-4B000	444128	R-E	CM	OIL	C	KSH-005RCO	55300-4B000	444023	E-E
					54300-4B500							55300-4B500	344102(GAS)	
					54300-4B700							55300-4B700		
PORTER HR														
04- PORTER 2 GRACE(CM) PORTER_AU(CM) 	CM	OIL	C	KSH-025FCO	54310-4F000	444128	R-E	CM	OIL	C	KSH-025RCO	55310-4F000	444340	E-E
					54300-4F000							55300-4F000		
												55300-4F300		
												55300-4F700		
		GAS	C	KSH-025FCG	54300-4F050	554095			GAS	C	KSH-025RCG	55300-4F350	554354	
											55300-4F050			
SONATA Y2														
88-93 	CM	OIL	S	KSH-040FCO	54650-33102	634063		CM	OIL	S-S	KSH-040RCO	55310-33200	441095	S-E
					54650-33200							55310-33102		
					54650-33500									
		GAS	S	KSH-040FCG	54650-33901	334058			GAS	S-S	KSH-040RCG	55310-33900	341154	
											55310-33901			
SONATA Y3														
93-98 	CM	OIL	S	KSH-041FCO	54650-34020	334141		CM	OIL	S-S	KSH-041RCO	55310-34020	341192	S-E
					54650-34200							55310-34102		
					54650-34220							55310-34220		
					54650-34230							55310-34230		
					54650-34231									
		GAS	S	KSH-041FCG	54650-34012				GAS	S-S	KSH-041RCG	55310-34000		
											55310-34130			
											55310-34310			

HYUNDAI

CAR NAME	FRONT							REAR						
	LH/RH/CM	GAS/OIL	TYPE	KIC FAC_NO	OE NO	KYB NO	REMARK	LH/RH/CM	GAS/OIL	TYPE	KIC FAC_NO	OE NO	KYB NO	REMARK
SONATA EF 98-MY														
98-01 GRANDGEUR_XG(CM) 	CM	OIL	S-S	KSH-013FCO	54611-38001	341280	S-C	CM	OIL	S-S	KSH-013RCO	55311-38000	341427	S-E (S/S UP)
					5431138651							55311-38650		
		GAS	S-S	KSH-013FCG	54611-38400				GAS	S-S	KSH-013RCG	55311-38400		
					54611-38500							55311-38500		
					54611-38650							55311-38900		
					54611-38700									
SONATA EF 01-MY														
04-09 OPTIMA(CM) 	CM	GAS	S-S	KSH-023FCG	54611-38600	341477	S-C	CM	GAS	S-S	KSH-023RCG	55311-38600	341478	S-E (S/S LW)
					54611-38601							55311-38601	341281	
					54611-38610							55311-38610		
					54611-38611									
					54611-38630									
SONATA NF														
04-09 GRANDGEUR_TG(CM) 	CM	GAS	S-S	KSH-024FCG	54611-3K010	341476	S-C	CM	GAS	C	KSH-024RCG	55311-3K010	349060	R-E
					54611-3K020							55311-3K020		
					54611-3K030							55311-3K030		
					54611-3K040							55311-3K040		
					54611-3K050							55311-3K050		
					54611-3K060							55311-3K060		
					54611-3K130							55311-3K130		
					54611-3K140							55311-3K630		
				54611-3K630							55311-3K770			
				54611-3K770							55311-3K780			
SONATA YF														
09- 	LH	GAS	S	KSH-046FLG	54651-3S010			CM	GAS	C	KSH-046RCG	55311-3S020		R-F TUCSON_IX (CM)
					54651-3S060							55311-3S060		
					54651-3S061							55311-3S010		
					54651-3S220							55311-2T230		SPORTAGE_R (CM)
					54651-3S020									
RH	GAS	S	KSH-046FRG	54661-3S010							54661-3S060			
				54661-3S061							54661-3S061			
				54661-3S220							54661-3S220			
				54661-3S020										
SONATA YF-US														
LH	GAS	S	KSH-054FLG	54651-3Q623										
				54651-3Q610										
	RH	GAS	S	KSH-054FRG	54661-3Q623							54661-3Q610		
SONATA LF 14-MY														
14-17 	LH	GAS	S	KSH-047FLG	54650-C1000			CM	GAS	C	KSH-047RCG	55311-C1100		R-E
					54650-C1050							55311-C1110		
					54650C1600							55311-C1200		
	RH	GAS	S	KSH-047FRG	54660-C1000									
					54660-C1050							54660-C1600		
				54660-C1600										
SONATA LF 17-MY														
16-18 	LH	GAS	S	KSH-055FLG	54650-C1055									P/ROD WRENCH TYPE K5_JF(CM)
					54650-C1070									
	RH	GAS	S	KSH-055FRG	54660-C1055							54660-C1670		

- KIA
- DAEWOO
- GM
- CHEVROLET
- RENAULT
- SAMSUNG
- SSANGYONG
- TOYOTA
- LEXUS
- NISSAN
- SUZUKI
- MAZDA
- ISUZU
- CHERY
- BYD
- GEELY
- FIAT
- CHRYSLER
- OPEL
- PEUGEOT

HYUNDAI



CAR NAME	FRONT							REAR								
	LH/RH/CM	GAS/OIL	TYPE	KIC FAC_NO	OE NO	KYB NO	REMARK	LH/RH/CM	GAS/OIL	TYPE	KIC FAC_NO	OE NO	KYB NO	REMARK		
STAREX A1																
	97-07	CM	OIL	C	KSH-042FCO	54310-4A000	344285	R-E	CM	OIL	C	KSH-L042RCO	55300-4A000	344286	E-E	
	1800					54310-4A500							55310-4A300		A1(LONG)	
	IMAX												55310-4A500			
			GAS	C	KSH-042FCG	54300-4A600				GAS	C	KSH-L042RCG	55310-4A700			
						54310-4A100										
						54310-4A110										
						54310-4A600										
						54610-4A700										
STAREX H1																
									CM	OIL	C	KSH-S042RCO	55310-4A000	344287	R-E	
										GAS	C	KSH-S042RCG	55310-4A100			
STAREX H1 4WD																
		CM	GAS	C	KSH-042FCG4-WD	54310-4A800		R-E	CM	OIL	C	KSH-042RCO-4WD	55310-4A800		R-E	
						54310-4A850							55310-4A850			
GRAND STAREX TQ																
	07-17	LH	GAS	S	KSH-017FLG	54650-4H000	339399		CM	GAS	C	KSH-S017RCG	55300-4H000	349166	E-E	
						54650-4H050							55300-4H050		WAGON	
						54650-4H100							55300-4H100			
						54650-4H150							55300-4H150			
						54650-4H600										
						54650-4H650										
			RH	GAS	S	KSH-017FRG	54660-4H000	339398								
							54660-4H050			CM	GAS	C	KSH-L017RCG-V	55300-4H500		E-E
						54660-4H100							55300-4H550			
						54660-4H150							55300-4H600			
						54660-4H600							55300-4H650			
						54660-4H650										
GRAND STAREX TQ 17-MY																
	17-	LH	GAS	S	KSH-060FLG	54650-4H055										
						54650-4H155										
						54650-4H655										
			RH	GAS	S	KSH-060FRG	54660-4H055									
							54660-4H155									
							54660-4H655									
SANTAFE SM																
	00-05	LH	GAS	S	KSH-028FLG	54650-26000	339749		CM	GAS	C	KSH-028RCG	55305-26000	349207	R-E	
						54650-26100							55305-26200			
						54650-26200							55305-26500			
						54650-26300							55305-26800			
						54650-26500							55305-26900			
						54650-26600										
			RH	GAS	S	KSH-028FRG	54660-26100	339748								
							54660-26000									
							54660-26200									
							54660-26300									
						54660-26500										
						54660-26600										

HYUNDAI

CAR NAME	FRONT							REAR							
	LH/RH/CM	GAS/OIL	TYPE	KIC FAC_NO	OE NO	KYB NO	REMARK	LH/RH/CM	GAS/OIL	TYPE	KIC FAC_NO	OE NO	KYB NO	REMARK	
SANTAFE CM 05-MY															
	05-12	LH	GAS	S	KSH-027FLG	54650-2B000	339751		CM	GAS	C	KSH-027RCG	55310-2B000	341716	E-E
						54650-2B001							55310-2B001		SANTAFE THE STYLE (CM)
						54650-2B100							55310-2B201		
						54650-2B200							55310-2B211		
						54650-2B201							55310-2B500		SORENTO_R (CM)
													55310-2B510		
													55310-2B520		
		RH	GAS	S	KSH-027FRG	54660-2B000	339750								
						54660-2B001									
						54660-2B100									
					54660-2B200										
					54660-2B201										
SANTAFE CM 09-MY															
	09-12	LH	GAS	S	KSH-032FLG	54650-2B500									
	SORENTO_R(CM)					54650-2B510									
						54650-2B540									
						54650-2B640									
		RH	GAS	S	KSH-032FRG	54660-2B500									
						54660-2B510									
					54660-2B540										
					54660-2B640										
SANTAFE DM															
	12-18	LH	GAS	S	KSH-033FLG	54651-2W000	335625		CM	GAS	C	KSH-033RCG	55310-2W010		E-E
	NEW SORENTO R_XM(CM)					54651-2W100							55310-2W100		
	(FRT REBOUND SPRING X)					54651-2W200							55310-2W110		
						54651-2W400							55310-2W500		
						54651-2W450							55310-2W550		
		RH	GAS	S	KSH-033FRG	54661-2W000	335624								
						54661-2W100							55310-2W300		E-E
						54661-2W200							55310-2W320		
						54661-2W400							55310-2W330		
						54661-2W450							55310-2W800		
												55310-2W850			
TUCSON JM															
	06-09	LH	GAS	S	KSH-044FLG	54651-2E000	339743		LH	GAS	S	KSH-044RLG	55351-2E000	339747	
	NEW SPORTAGE (CM)					54651-2E001							55351-2E001		
						54651-2E200							55351-2E002		
						54651-2E201							55351-2E200		
						54651-2E500							55351-2E202		
													55351-2E501		
		RH	GAS	S	KSH-044FRG	54661-2E000	339742		RH	GAS	S	KSH-044RRG	55361-2E000	339746	
						54661-2E001							55361-2E001		
						54661-2E200							55361-2E002		
						54661-2E201							55361-2E200		
					54661-2E500							55361-2E202			
												55361-2E501			

HYUNDAI
KIA
DAEWOO
GM
CHEVROLET
RENAULT
SAMSUNG
SSANGYONG
TOYOTA
LEXUS
NISSAN
SUZUKI
MITSUBISHI
MAZDA
ISUZU
CHERY
BYD
GEELY
FIAT
CHRYSLER
OPEL
PEUGEOT

HYUNDAI

CAR NAME	FRONT							REAR						
	LH/RH/CM	GAS/OIL	TYPE	KIC FAC_NO	OE NO	KYB NO	REMARK	LH/RH/CM	GAS/OIL	TYPE	KIC FAC_NO	OE NO	KYB NO	REMARK
TUCSON LM														
10-IX 35 	LH	GAS	S	KSH-045FLG	54651-2S000	339403		CM	GAS	C	KSH-045RCG	55311-2S000	349243	R-F SPRTAGER (CM)
					54651-2S050							55311-2S010		
					54651-2S100							55311-2S011		
					54651-2S300							55311-2S050		
					54651-2S550							55311-2S650		
					54651-2S650							55311-2S850		
	RH	GAS	S	KSH-045FRG	54661-2S000	339402		CM	GAS	C	KSH-045RCG-4WD	55311-2S400	349187	R-E SPRTAGER 4WD(CM)
					54661-2S050							55311-2S450		
					54661-2S100							55311-2S411		
					54661-2S550							55311-2S950		
TUCSON TL														
15- 	LH	GAS	S	KSH-049FLG	54651-D3000		CM	GAS	C	KSH-049RCG	55311-D3000		R-E	
	RH	GAS	S	KSH-049FRG	54661-D3000						55311-D3220			
TUCSON TLE														
15- 	LH	GAS	S	KSH-049FLG-16	54650-D7000									
	RH	GAS	S	KSH-049FRG-16	54660-D7000									
TRAJET FO														
02-07 	LH	GAS	S	KSH-043FLG	54650-3A200	334238		CM	GAS	C	KSH-043RCG	55300-3A000	344297	E-E
					54650-3A501							55300-3A010		
					54650-3A502							55300-3A500		
					54650-3A505							55300-3A501		
	RH	GAS	S	KSH-043FRG	54660-3A200	334237		CM	GAS	C	KSH-043RCG	55300-3A505	344297	E-E
					54660-3A501							55300-3A510		
TIBURON RD														
96-99 AVANTE RD(CM) 	LH	GAS	S	KSH-058FLG	54650-27130	333206		LH	GAS	S	KSH-058RLG	55351-27130	333208	
					54651-27300							55351-27300		
					54651-29650									
	RH	GAS	S	KSH-058FRG	54660-27130	333205		RH	GAS	S	KSH-058RRG	55361-27130	333207	
					54661-27300							55361-27300		
					54661-29650									
TUSCANI GK														
01-08 	LH	GAS	S	KSH-059RLG	55350-2C000	333782	Undeveloped	LH	GAS	S	KSH-059RRG	55360-2C000	333781	AVANTE_XD(CM)
					55351-2C000							55361-2C000		

HYUNDAI

CAR NAME	FRONT							REAR						
	LH/RH/CM	GAS/OIL	TYPE	KIC FAC_NO	OE NO	KYB NO	REMARK	LH/RH/CM	GAS/OIL	TYPE	KIC FAC_NO	OE NO	KYB NO	REMARK
VERNA LC														
99-05 ACCENT 	LH	OIL	S	KSH-021FLO	54650-25000	333305		LH	OIL	S	KSH-021RLO	55350-25000	332109	
					54650-25050							55350-25050		
					54650-25100							55350-25100		
					54650-25150							55350-25101		
					54650-25500							55350-25150		
					54650-25550							55350-25151		
	RH	GAS	S	KSH-021FLG	54650-25600	333305		RH	GAS	S	KSH-021RLG	55350-25600	332109	
					54650-25650							55350-25650		
					54650-25700							55350-25700		
					54650-25750							55350-25750		
VERNA MC														
05-11 NEW ACCENT 	LH	GAS	S	KSH-022FLG	54650-1E000	333517	JB PRIDE(CM) ONLY FRT	CM	GAS	C	KSH-022RCG	55310-1E000	348002	R-E
					54650-1E100							55310-1E100		
					54650-1E200							55310-1E150		
					54650-1E300							55310-1E200		
	RH	GAS	S	KSH-022FRG	54660-1E000	333516		RH	GAS	S	KSH-022RRG	55360-25600	332108	
					54660-1E100							55360-25650		
VELOSTER FS														
11-14 	LH	GAS	S	KSH-039FLG	54651-2V050			LH	GAS	S	KSH-039FLG	54651-2V050		Undeveloped
					54651-2V150							54651-2V351		
					54651-2V360							54651-2V930		
					54651-2V930							54651-2V900		
					54651-2V350							54651-2V350		
					54651-2V350							54651-2V350		
	RH	GAS	S	KSH-039FRG	54661-2V050			RH	GAS	S	KSH-039FRG	54661-2V150		
					54661-2V351							54661-2V360		
					54661-2V930							54661-2V900		
					54661-2V350							54661-2V350		

KIA

CAR NAME	FRONT							REAR						
	LH/RH/CM	GAS/OIL	TYPE	KIC FAC_NO	OE NO	KYB NO	REMARK	LH/RH/CM	GAS/OIL	TYPE	KIC FAC_NO	OE NO	KYB NO	REMARK
BESTA F70Y														
86-97 BONGO FRONTIER (CM) 	CM	OIL	C	KSK-001FCO	0K71E-34-700	444162	R-E(XPIN)	CM	OIL	C	KSK-001RCO	0K71E-28-700	443302	E-E
					0K710-34-700	344302						0K721-28-700	344063	
BONGO FORNTIER BA2														
97-02 BESTA(CM) 	CM	OIL	C	KSK-001FCO-BF	0K06A-34-700A	444162	R-E(XPIN)	CM	OIL	C	KSK-001RCO-BF	0K06A-28-700B	444025	E-E
					M71E-34-700	344302						0K06A-28-700A	344063	
												0K60A-28-700C		
BONG03 PU														
04-11 K2900 	CM	GAS	C	KSK-004FCG	54300-4E000	3440046	R-E	CM	GAS	C	KSK-004RCG	55300-4E000	3440031	E-E
					54300-4E100							55300-4E100	349154	
					54300-4E101							55300-4E400		
												55310-4E000		
BONG03 PU K25														
BONGO FRONTIER(CM) BESTA(CM)	CM	OIL	C	KSK-001FCO-K25	54300-4E200	344302	R-E(xpin)							
BONG03 PU 1.4T														
	CM	GAS	C	KSK-002FCG	54300-4E600		R-E	CM	GAS	C	KSK-002RCG	55300-4E600		R-R
					54300-4E700							55300-4E700		
												55310-4E600		
												55310-4E700		
CEED ED														
07-11 I30_FD(CM) 	LH	GAS	S	KSK-006FLG	54651-1H100	339258		CM	GAS	C	KSK-006RCG	55311-1H100	349084	R-F
					54651-1H000	338025						55310-1H102		
	RH	GAS	S	KSK-006FRG	54661-1H100	339257								
					54661-1H000	338024								
CEED ED SW														
10-13 	LH	GAS	S	KSK-006FLG-SW	54651-1H600									
					54651-1H700									
	RH	GAS	S	KSK-006FRG-SW	54661-1H600									
					54661-1H700									
CERATO LD														
03-08 SPECTRA 	LH	GAS	S	KSK-005FLG	54651-2F000	333491		LH	GAS	S	KSK-005RLG	55351-2F000	333493	
					54651-2F100							55351-2F100		
					54651-2F200							55351-2F200		
					54651-2F300							55351-2F300		
					54651-2F400							55351-2F301		
					54651-2F500							55351-2F400		
												55351-2F401		
												55351-2F500		
		RH	GAS	S	KSK-005FRG	54661-2F000	333490		RH	GAS	S	KSK-005RRG	55361-2F000	333492
					54661-2F100							55361-2F100		
				54661-2F200							55361-2F200			
				54661-2F300							55361-2F300			
				54661-2F400							55361-2F301			
				54661-2F500							55361-2F400			
											55361-2F401			
											55361-2F500			

KIA

CAR NAME	FRONT							REAR						
	LH/RH/CM	GAS/OIL	TYPE	KIC FAC_NO	OE NO	KYB NO	REMARK	LH/RH/CM	GAS/OIL	TYPE	KIC FAC_NO	OE NO	KYB NO	REMARK
CARENS RS 99-MY														
02-06 	LH	GAS	S	KSK-045FLG	0K2FB-34-900C		Brk't-3EA	LH	GAS	S	KSK-045RLG	0K2FB-28-900B		
												0K2JB-28-900B		
	RH	GAS	S	KSK-045FRG	0K2FB-34-700C									
	LH	GAS	S	KSK-046FLG	0K2JB-34-900A		Brk't-3EA					0K2JB-28-700B		
	RH	GAS	S	KSK-046FRG	0K2JB-34-700A									
CARENS UN														
06-13 	LH	GAS	S	KSK-013FLG	54651-1D000	334509		CM	GAS	C	KSK-013RCG	55311-1D000	344501	R-F
					54651-1D001							55311-1D010		
					54651-1D100							55311-1D020		
					54651-1D101							55311-1D200		
					54651-1D200							55311-1D400		
					54651-1D201									
	RH	GAS	S	KSK-013FRG	54661-1D000	334508								
					54661-1D001									
					54661-1D100									
					54661-1D101									
					54661-1D200									
					54661-1D201									
CARNIVAL KV2														
98-01 	LH	GAS	S	KSK-030FLG	0K552-34-900B	335043		CM	GAS	C	KSK-030RCG	0K53A-28-700C	344296	R-E
					0K552-34-900E							0K552-28-700		
					0K553-34-900C							0K552-28-700A		
					0K55B-34-900							0K552-28-700C		
												0K552-28-700E		
												0K55A-28-700		
	RH	GAS	S	KSK-030FRG	0K552-34-700B	335042								
					0K552-34-700E									
					0K553-34-700A									
					0K553-34-700C									
GRAND CARNIVAL VQ														
05-10 	LH	GAS	S	KSK-031FLG	54651-4D000	339310		CM	GAS	C	KSK-031RCG	55310-4D000	349094	R-E
					54651-4D001							55310-4D100		
					54651-4D100							55310-4D600		
					54651-4D101									
	RH	GAS	S	KSK-031FRG	54661-4D000	339309								
					54661-4D001									
					54661-4D100									
					54661-4D101									
FORTE TD														
08-13 FORTE/ CERATO 	LH	GAS	S	KSK-008FLG	54650-1M000	338027		CM	GAS	C	KSK-008RCG	55300-1M000	554385	E-E
					54650-1M300							55300-1M300		
					54650-1M310							55300-1M350		
					54650-1M510									
		RH	GAS	S	KSK-008FRG	54660-1M000	338026							
						54660-1M300								
					54660-1M310									
					54660-1M510									

KIA



KIA

CAR NAME	FRONT							REAR							
	LH/RH/CM	GAS/OIL	TYPE	KIC FAC_NO	OE NO	KYB NO	REMARK	LH/RH/CM	GAS/OIL	TYPE	KIC FAC_NO	OE NO	KYB NO	REMARK	
K3 YD															
12-18 FORTE 	LH	GAS	S	KSK-032FLG	54651-A7000	3440062		CM	GAS	C	KSK-032RCG	55300-A7000	349184	E-E	
					54651-A7100							55300-A7100			
					54651-A7210							55300-A7200			
					54651-A7300							55300-A7400			
					54651-A7400										
	RH	GAS	S	KSK-032FRG	54661-A7000	3440061									
					54661-A7100										
					54661-A7210										
					54661-A7300										
					54661-A7400										
54661-A7AB0															
K5 TF															
10-15 2.4L OPTIMA 	LH	GAS	S	KSK-009FLG	54651-2T011			CM	GAS	C	KSK-009RCG	55311-2T010		R-F	
					54651-2T021							Ø14HOLE STABILINKBACK			55311-2T020
					54651-2T120										55311-2T230
					54651-2T230										
	RH	GAS	S	KSK-009FRG	54661-2T011										
					54661-2T021										
					54661-2T120										
					54661-2T230										
K5 TF TGD															
DYNAMIC DAMPER	LH	GAS	S	KSK-033FLG	54651-2T010										
					54651-2T020										Ø14HOLE STABILINKBACK
					54651-4R010										
	RH	GAS	S	KSK-033FRG	54661-2T010										
					54661-2T020										
					54661-4R010										
K5 TF SX															
SX	LH	GAS	S	KSK-009FLG-16	54651-2T012										
					54651-2T232										Ø16HOLE STABILINKBACK
					54651-2T250										
					54651-2T022										
	RH	GAS	S	KSK-009FRG-16	54661-2T022										
					54661-2T232										
					54661-2T250										
					54661-2T012										
K5 TF EX															
11-EX 2.0L	LH	GAS	S	KSK-016FLG	54651-2T124										
					54651-2T224										Ø16HOLE STABILINKBACK
					54651-2T410										
					54651-2T420										
					54651-2T430										
					54651-2T440										
					54651-2T450										
					54651-2T460										
					54651-2T470										
					54651-4R025										HYBRID
					54651-3V281										

CAR NAME	FRONT							REAR							
	LH/RH/CM	GAS/OIL	TYPE	KIC FAC_NO	OE NO	KYB NO	REMARK	LH/RH/CM	GAS/OIL	TYPE	KIC FAC_NO	OE NO	KYB NO	REMARK	
K5 TF EX															
11-EX 2.0L 	RH	GAS	S	KSK-016FRG	54661-2T124										
					54661-2T224										
					54661-2T410										
					54661-2T420										
					54661-2T430										
					54661-2T440										
					54661-2T450										
					54661-2T460										
					54661-2T470										
					54661-4R025										HYBRID
54661-3V281															
K5 JF															
15-20 SONATA LFINNEW RISE) CM 	LH	GAS	S	KSK-042FLG	54650-D4000						KSK-042RCG	55311-D4000		R-E	
					54650-D4500							P/ROD WRENCH TYPE Ø16HOLE			55311-D4110
					54650-D4580										55311-D4200
	RH	GAS	S	KSK-042FRG	54660-D4000										
					54660-D4500										
					54660-D4580										
K7 VG															
10-13 2.4-2.7L CADENZA 	LH	GAS	S	KSK-043FLG	54651-3R021			Ø14HOLE	CM	GAS	C	KSK-007RCG	55311-3R020	R-F	
	RH	GAS	S	KSK-043FRG	54661-3R021										
K7 VG SX															
11-12 3.0-3.3L 2012 CADENZA 	LH	GAS	S	KSK-007FLG	54651-3R130									Ø16HOLE	
					54651-3R330										
	RH	GAS	S	KSK-007FRG	54661-3R130										
					54661-3R330										
K7 VG EX															
13-16 EX 	LH	GAS	S	KSK-037FLG	54651-3R800										
					54651-3R900										Ø16HOLE
	RH	GAS	S	KSK-037FRG	54661-3R800										R-F GRANDEUR_HG [CM] (ONLY RR)
					54661-3R900										
LOTZE MG															
05-10 MAGENTIS 	LH	GAS	S	KSK-010FLG	54651-2G000									R-F	
					54651-2G200										
					54651-2G300										
					54651-2G310										
					54651-2G400										
					54651-2G410										
					54651-2G600										
					54651-2G610										
					54651-2G630										
					54651-2G700										

- HYUNDAI
- KIA**
- DAEWOO
- GM
- CHEVROLET
- RENAULT
- SAMSUNG
- SSANGYONG
- TOYOTA
- LEXUS
- NISSAN
- SUZUKI
- MITSUBISHI
- MAZDA
- ISUZU
- CHERY
- BYD
- GEELY
- FIAT
- CHRYSLER
- OPEL
- PEUGEOT

KIA

CAR NAME	FRONT						REAR							
	LH/RH/CM	GAS/OIL	TYPE	KIC FAC_NO	OE NO	KYB NO	REMARK	LH/RH/CM	GAS/OIL	TYPE	KIC FAC_NO	OE NO	KYB NO	REMARK
LOTZE MG														
05-10 MAGENTIS 	RH	GAS	S	KSK-010FRG	54661-2G000									
					54661-2G200									
					54661-2G300									
					54661-2G310									
					54661-2G400									
					54661-2G410									
					54661-2G600									
					54661-2G610									
					54661-2G630									
				54661-2G700										
MORNING SA														
04-11 110_PA(CM) PICANTO 	LH	OIL	S	KSK-011FLO	54650-07000	332501		CM	OIL	C	KSK-011RCO	55310-07000	343405	R-E
					54650-07100							55310-07001		
					54650-07200							55310-07100		
												55310-07200		
	RH	OIL	S	KSK-011FRO	54660-07000	332500								
					54660-07100								54660-07200	
MORNING TA														
11-17 	LH	GAS	S	KSK-012FLG	54650-1Y000	3320021		CM	GAS	C	KSK-012RCG	55300-1Y000	348053	R-E
					54650-1Y001							55300-1Y200		
					54650-1Y010							55310-1Y000		
					54650-1Y100							55310-1Y100		
					54650-1Y200							55310-1Y200		
					54650-1Y201									
	RH	GAS	S	KSK-012FRG	54660-1Y000	3320020								
					54660-1Y001									
					54660-1Y010									
					54660-1Y100									
				54660-1Y200										
				54660-1Y201										
MORNING JA														
17- 	LH	GAS	S	KSK-044FLG	54650-G6000			CM	GAS	C	KSK-044RCG	55310-G6000		R-E
					54650-G6100									
	RH	GAS	S	KSK-044FRG	54660-G6000									
				54660-G6100										
MOHAVE HM														
08-16 	CM	GAS	S-S	KSK-036FCG	54651-2J001		S-E	LH	GAS	C	KSK-036RLG	55310-2J000		R-E
					54651-2J100							55310-2J100		
					54651-2J300							55310-2J300		
					54651-2J320							55310-2J401		
								RH	GAS	C	KSK-036RRG	55320-2J000		
												55320-2J100		
												55320-2J300		
OPTIMA MS														
00-05 NEW EF SONATA(CM) 	CM	GAS	S-S	KSK-034FCG	54311-38600	341477	S-C	CM	GAS	S-S	KSK-034RCG	55311-38600		S-E
					54611-38600							55311-38601		
					54611-38601							55311-38610		
					54611-38610									
					54611-38630									
		OIL	S-S	KSK-034FCO	54311-38600YO				OIL	S-S	KSK-034RCO	55311-38600YO		

KIA

CAR NAME	FRONT						REAR							
	LH/RH/CM	GAS/OIL	TYPE	KIC FAC_NO	OE NO	KYB NO	REMARK	LH/RH/CM	GAS/OIL	TYPE	KIC FAC_NO	OE NO	KYB NO	REMARK
PREGIO NB9														
95-04 	CM	GAS	S-S	KSK-018FCG	0K72A-34-700	341247	S-C	CM	GAS	C	KSK-S018RCG	0K72A-28-700		R-E
					0K72A-34-710							0K79A-28-700		COACH
					0K72A-34-710A							0K72A-28-700A		SHORT
					0K72A-34-710B							0K72A-28-700C		
					0K72A-34-910C							0K72A-28-701D		
					0K72A-34-910D									
					0K72A-34-920									
					0K79A-34-710									
PRIDE NB3														
87-00 RIO1 	LH	OIL	S	KSK-019FLO	KK137-34-900	332055		CM	OIL	S-S	KSK-019RCO	KK135-28-700	341079	S-E
					KK137-34-900A							KK135-28-700A		
					KKY01-34-900							KK135-28-700B		
					KKY01-34-900B							KK153-28-700		
					MD001-34-900A							KK153-28-700B		
												KKY01-28-700		
	RH	OIL	S	KSK-019FRO	KK137-34-700	332054						KKY01-28-700D		
					KK137-34-700A							KKY01-28-700Z		
					KKY01-34-700							MD001-28-700H		
					KKY01-34-700B							MD001-28-700K		
				MD001-34-700A										
PRIDE JB														
05-11 NEW RIO 	LH	GAS	S	KSK-014FLG	54650-1G000	3330051	MC VERNAL(CM)	CM	GAS	C	KSK-014RCG	55310-1G010	348007	R-E
					54650-1G100		ONLY FRT					55310-1G110		
					54650-1G200							55310-1G120		
					54650-1G400							55310-1G210		
												55310-1G300		
RH	GAS	S	KSK-014FRG	54660-1G000	3330050									
				54660-1G100										
				54660-1G200										
				54660-1G400										
PRIDE UB														
11- RIO3 	LH	GAS	S	KSK-020FLG	54650-1W030	338107		CM	GAS	C	KSK-020RCG	55300-1W000	554384	E-E
					54650-1W051							55300-1W100		
					54650-1W100							55300-1W200		
					54650-1W200							55300-1W400		
					54650-1W400									
	RH	GAS	S	KSK-020FRG	54660-1W030	338106								
				54660-1W051										
				54660-1W100										
				54660-1W200										
				54660-1W400										
RIO BC SF														
02-05 	LH	GAS	S	KSK-023FLG	54650-FD000	333513		CM	GAS	C	KSK-023RCG	55310-FD000	343424	E-EXPIN
					54650-FD050							55310-FD051		
					54650-FD100							55310-FD150		99-01
					54650-FD101							55310-FD200		
	RH	GAS	S	KSK-023FRG	54660-FD000	333512								
				54660-FD050										
				54660-FD100										
				54660-FD101										

KIA

CAR NAME	FRONT							REAR						
	LH/RH/CM	GAS/OIL	TYPE	KIC FAC_NO	OE NO	KYB NO	REMARK	LH/RH/CM	GAS/OIL	TYPE	KIC FAC_NO	OE NO	KYB NO	REMARK
RIO BC														
99-00	LH	OIL	S	KSK-021FLO	OK30A-34-900H		99	CM	OIL	C	KSK-021RCO	OK30A-28-700	343353	E-EX-PIN
												OK30A-28-700K		
	RH	OIL	S	KSK-021FRO	OK30A-34-700H							OK33C-28-700		99-01
												OK33C-28-700A		
RIO BC 00-MY														
00-01	LH	OIL	S	KSK-022FLO	OK30A-34-900J	333503	01							
					OK30A-34-900K									
					OK32B-34-900									
					OK33C-34-900F									
	RH	OIL	S	KSK-022FRO	OK30A-34-700J	333502								
					OK30A-34-700K									
					OK32B-34-700									
					OK33C-34-700F									
SEPHIA S1														
92-97	LH	OIL	S	KSK-024FLO	OK201-34-900E	633169		LH	OIL	S	KSK-024RLO	OK201-28-900	333372	
												OK216-28-900		
					OK203-34-900	333110						OK216-28-900A		
					OK203-34-900B							OK216-28-900B		
					OK203-34-900F							OK216-28-900C		
					OK203-34-900G							OK216-34-900		
					OK216-34-900A							OK216-34-900A		
	RH	OIL	S	KSK-024FRO	OK201-34-700E	633168		RH	OIL	S	KSK-024RRO	OK201-28-700	333371	
												OK201-28-700B		
					OK203-34-700	333109						OK201-28-700C		
					OK203-34-700E							OK201-28-700D		
					OK203-34-700G							OK201-28-700E		
					OK216-34-700							OK201-28-700F		
					OK216-34-700A							OK216-28-700		
												OK216-28-700B		
												OK216-28-700C		
SEPHIA S2														
97-00	LH	GAS	S	KSK-025FLG	OK2A1-34-900	333263		LH	GAS	S	KSK-025RLG	OK2A1-28-900	333265	
												OK2A3-28-900		
					OK2A3-34-900							OK2A1-28-900B		
					OK2A1-34-900C							OK2A1-28-900C		
					OK2A1-34-900D							OK2A1-28-900D		
					OK2A1-34-900E							OK2A3-28-900B		
					OK2A1-34-900F							OK2A3-28-900C		
					OK2A1-34-900G							OK2A3-28-900D		
					OK2A3-34-900D							OK2A3-28-900D		
					OK2A3-34-900E							OK2A3-28-900E		
					OK2A3-34-900F									
					OK2A3-34-900G									
					OK2A3-34-900H									
	RH	GAS	S	KSK-025FRG	OK2A1-34-700	333262		RH	GAS	S	KSK-025RRG	OK2A1-28-700	333264	
												OK2A3-28-700		
					OK2A1-34-700D							OK2A1-28-700B		
					OK2A1-34-700E							OK2A1-28-700C		
					OK2A1-34-700F							OK2A1-28-700D		
					OK2A1-34-700G							OK2A3-28-700B		
					OK2A3-34-700D							OK2A3-28-700C		
					OK2A3-34-700E							OK2A3-28-700D		
					OK2A3-34-700F							OK2A3-28-700E		
					OK2A3-34-700G									



KIA

CAR NAME	FRONT							REAR							
	LH/RH/CM	GAS/OIL	TYPE	KIC FAC_NO	OE NO	KYB NO	REMARK	LH/RH/CM	GAS/OIL	TYPE	KIC FAC_NO	OE NO	KYB NO	REMARK	
SPECTRA SD															
00-03 SHUMA1-2	LH	GAS	S	KSK-026FLG	OK2NA-34-900A	333317		LH	GAS	S	KSK-026RLG	OK2N1-28-900A	333303		
												OK2N3-28-900A			
					OK2NB-34-900A							OK2NE-28-900A			
					OK2NE-34-900							OK2NF-28-900A			
					OK2NF-34-900							OK2N1-28-700A	333302		
	RH	GAS	S	KSK-026FRG	OK2NA-34-700A	333316		RH	GAS	S	KSK-026RRG	OK2N1-28-700A			
												OK2N3-28-700A			
					OK2NB-34-700A							OK2NE-28-700A			
					OK2NE-34-700							OK2NF-28-700A			
					OK2NF-34-700A										
SPORTAGE KM															
04-10 TUCSON_JM(CM)	LH	GAS	S	KSK-003FLG	54651-1F000	339743		LH	GAS	S	KSK-003RLG	55351-1F000	339747		
												55351-1F500			
	RH	GAS	S	KSK-003FRG	54661-1F000	339742		RH	GAS	S	KSK-003RRG	55361-1F000	339746		
												55361-1F500			
SPORTAGE R SL															
10-13	LH	GAS	S	KSK-027FLG	54651-3W050	339403		CM	GAS	C	KSK-027RCG	55311-3W050		R-F TUCSON_IX (CM)	
												55311-3W010			
					54651-3W550							55311-3W870			
					54651-3W600										
	RH	GAS	S	KSK-027FRG	54661-3W050	339402		4WD							
								CM	GAS	C	KSK-027RCG-4WD	55311-3W450	349187	R-F TUCSON_IX 4WD(CM)	
					54661-3W550							55311-3W410			
					54661-3W600										
SPORTAGE QL															
15-18 TUCSON_TL(CM)	LH	GAS	S	KSK-047FLG	54650-D9200		NORMAL	CM	GAS	C	KSK-047RCG	55311-D9200		R-E NORMAL	
												55311-D9210		NORMAL	
					54650-D9000		2WD(HPD)					55311-D9100		2WD(HPD)	
					54650-D9050		4WD(HPD)					55311-D9110		4WD(HPD)	
	RH	GAS	S	KSK-047FRG	54660-D9200		NORMAL								
					54660-D9000		2WD(HPD)								
					54660-D9050		4WD(HPD)								
SORENTO BL 02-MY															
02-09	LH	GAS	S-S	KSK-015FLG	54630-3E000	341365	S-E	CM	GAS	C	KSK-015RCG	55300-3E000	344451	E-E	
												55300-3E010			
					54630-3E00S			02-06				55300-3E020			
					54630-3E010							55300-3E021			
					54630-3E020							55300-3E022			
					54630-3E021							55300-3E030			
					54630-3E022							55300-3E031			
					54630-3E023							55300-3E100			
					54630-3E030							55300-3E050			
					54630-3E031							55300-3E060			
					54630-3E032							55300-3E070			
					54630-3E100							55300-3E200			
					54630-3E200							55300-3E300			
					54630-3E300										
	RH	GAS	S-S	KSK-015FRG	54640-3E000	341364		SORENTO BL 06-MY							
								CM	GAS	C	KSK-017RCG	55310-3E001	349115	R-E	
					54640-3E00S							55310-3E500			
					54640-3E010							55310-3E600			
					54640-3E020										
					54640-3E021										
					54640-3E022										
					54640-3E023										

KIA

CAR NAME	FRONT							REAR							
	LH/RH/CM	GAS/OIL	TYPE	KIC FAC_NO	OE NO	KYB NO	REMARK	LH/RH/CM	GAS/OIL	TYPE	KIC FAC_NO	OE NO	KYB NO	REMARK	
SORNETO XM															
09-14 	LH	GAS	S	KSK-028FLG	54650-1U300	3340122		CM	GAS	C	KSK-028RCG	55310-2P000	341716	E-E	
					54650-2P000							55310-2P100	3440028		
					54650-2P100							55310-2P200			
					54650-2P500							55310-2P300			
												55310-2P600			
	RH	GAS	S	KSK-028FRG	54660-1U300	3340121		4WD							
					54660-2P000		CM	GAS	C	KSK-035RCG	55310-2P500	3440072	E-E		
					54660-2P100										
					54660-2P500										
SORENTO XM 12-MY															
12-14 SANTAFE DM(CM) (FRT REBOUND SPRING X) 	LH	GAS	S	KSK-028FLG-N	54651-2P400			CM	GAS	C	KSK-028RCG-N	55310-2P400		E-E	
					54651-2P900		1309-1410					55310-2P430			
	RH	GAS	S	KSK-028FRG-N	54661-2P400										
					54661-2P900		1309-1410								
SORENTO UM															
14- 	LH	GAS	S	KSK-040FLG	54650-C5000			CM	GAS	C	KSK-040RCG	55310-C5000		R-F	
					54651-C5100							55310-C5050			
					54651-C5000										
					54651-C5150										
	RH	GAS	S	KSK-040FRG	54660-C5000										
					54661-C5100										
					54661-C5000										
					54661-C5150										
SOUL AM															
08-13 	LH	GAS	S	KSK-029FLG	54650-2K000			CM	GAS	C	KSK-029RCG	55300-2K000	349132	E-E	
					54650-2K100							55300-2K100			
					54650-2K200							55300-2K200			
					54650-2K300							55300-2K300			
					54650-2K800							55300-2K500			
					54650-2K820							55300-2K800			
					54650-2K930							55300-2K960			
					54650-2K960										
		RH	GAS	S	KSK-029FRG	54660-2K000									
						54660-2K100									
						54660-2K200									
						54660-2K300									
					54660-2K800										
					54660-2K820										
					54660-2K930										
					54660-2K960										
SOUL PS															
13-16 	LH	GAS	S	KSK-038FLG	54650-B2000			CM	GAS	C	KSK-038RCG	55300-B2030		R-E	
					54650-B2030							55300-B2040			
					54650-B2040		EUROPE					55300-B2130			
					54650-B2100							55310-B2000			
												55310-B2030			
												55310-B2040			
						54660-B2040		EUROPE				55310-B2100			
	RH	GAS	S	KSK-038FRG	54660-B2000										
					54660-B2030										
					54660-B2040										
					54660-B2100										

KIA

CAR NAME	FRONT							REAR						
	LH/RH/CM	GAS/OIL	TYPE	KIC FAC_NO	OE NO	KYB NO	REMARK	LH/RH/CM	GAS/OIL	TYPE	KIC FAC_NO	OE NO	KYB NO	REMARK
TOWNER S80														
92-02 	LH	GAS	S-S	KSK-039FLG	AA100-34-900B		S-C	CM	OIL	C	KSK-039RCO	AA100-28-700		E-E
								TOWNER S80 VAN						
	RH	GAS	S-S	KSK-039FRG	AA100-34-700B			CM	OIL	C	KSK-039RCO-VAN	AA110-28-700AS		E-E
VENGA YN														
09-19 	LH	GAS	S	KSK-041FLG	54650-1P100									Undeveloped
	RH	GAS	S	KSK-041FRG	54660-1P100									

- HYUNDAI
- KIA**
- DAEWOO
GM
CHEVROLET
- RENAULT
SAMSUNG
- SSANGYONG
- TOYOTA
LEXUS
- NISSAN
- SUZUKI
- MITSUBISHI
- MAZDA
- ISUZU
- CHERY
- BYD
- GEELY
- FIAT
- CHRYSLER
- OPEL
- PEUGEOT



DAEWOO/GM/CHEVROLET

CAR NAME	FRONT							REAR						
	LH/RH/CM	GAS/OIL	TYPE	KIC FAC_NO	OE NO	KYB NO	REMARK	LH/RH/CM	GAS/OIL	TYPE	KIC FAC_NO	OE NO	KYB NO	REMARK
NUBIRA J100														
97-99 	LH	OIL	S	KSD-013FLO	96249294	334210		LH	OIL	S	KSD-013RLO	96289901	333255	
					96249296							96289907		
					96249302							96297200		
					96253926							96300279		
					96253930							98289907		
					96253932									
					96289801									
					96289803									
					96300113									
					96491211									
					96491213									
					96491214									
					96491223									
					96491225									
					96491227									
					96491229									
					96491250									
					96491252									
					96491254									
	RH	OIL	S	KSD-013FRO	96249295	334209		RH	OIL	S	KSD-013RRO	96289902	333254	
					96249297							96289908		
					96249303							96297201		
					96253927							96300280		
					96253931							98289908		
					96253933									
					96289802									
					96289804									
					96300114									
					96491212									
					96491215									
					96491224									
					96491226									
					96491228									
					96491230									
					96491251									
					96491255									
REZZO U100														
01-02 TACUMA 	LH	OIL	S	KSD-015FLO	96286840			CM	GAS	C	KSD-015RCG	96261066	553339	E-E
					96286842									
					96343157									
					96399291									
	RH	OIL	S	KSD-015FRO	96286841									
					96286843									
					96343158									
					96399292									





DAEWOO/GM/CHEVROLET

CAR NAME	FRONT							REAR						
	LH/RH/CM	GAS/OIL	TYPE	KIC FAC_NO	OE NO	KYB NO	REMARK	LH/RH/CM	GAS/OIL	TYPE	KIC FAC_NO	OE NO	KYB NO	REMARK
SPARK M300														
11-15 	LH	GAS	S	KSD-020FLG	54025462			CM	GAS	C	KSD-020RCG	94579195	348036	R-E
					95025460							95026518		
					95032443							95026519		
					95032445							95259950		
					95032447							95325940		
					95325958							95967519		
					96071861							95967520		
					96682475							95967521		
	RH	GAS	S	KSD-020FRG	95025461									
					95032444									
					95032446									
					95032448									
					95325959									
					96032446									
					96071862									
TICO SCAR														
91-01 	LH	OIL	S	KSD-016FLO	4160278B00	632094		CM	OIL	C	KSD-016RCO	41800A78B00	342020	E-E
					41602A78B01							41800A78B10		
					41602A78B02							41800A78B20		
					41602A78B10							41800A78B30		
					41602M70F00							41800A78BX0		
	RH	OIL	S	KSD-016FRO	4160178B00	632093								
					41601A78B01									
					41601A78B02									
					41601A78B10									
					41601M70F00									
TOSCA V250														
06-10 	LH	GAS	S	KSD-017FLG	96639829			LH	GAS	S	KSD-017RLG	96639685	341737	EPICA(CM)
					96639837							96639689		(ONLY RR)
					96639835									
	RH	GAS	S	KSD-017FRG	96639830			RH	GAS	S	KSD-017RRG	96639686	341731	
					96639838							96639690		
					96639836									
EPICA V250														
06-10 	LH	GAS	S	KSD-018FLG	96943771	339791		LH	GAS	S	KSD-018RLG	96943781	341737	TOSCA(CM)
					96943779							96943787		(ONLY RR)
					96433771									
	RH	GAS	S	KSD-018FRG	96943772	339790		RH	GAS	S	KSD-018RRG	96943782	341731	
					96943780							96943788		
					96433772									
WINSTORM C100														
06-10 	LH	GAS	S	KSD-021FLG	25983392			CM	GAS	C	KSD-021RCG	25995943	345084	E-E
					95948809							96626214		
					96626301							96626215		
					96858475							96626452		
												96819164		
	RH	GAS	S	KSD-021FRG	25983393							96863972		
					95948810									
					96626302									
					96858476									

DAEWOO/GM/CHEVROLET

CAR NAME	FRONT							REAR						
	LH/RH/CM	GAS/OIL	TYPE	KIC FAC_NO	OE NO	KYB NO	REMARK	LH/RH/CM	GAS/OIL	TYPE	KIC FAC_NO	OE NO	KYB NO	REMARK
CAPTIVA C140														
	LH	GAS	S	KSD-023FLG	95147607	335845	REBOUND SPRING							
					95166266									
	RH	GAS	S	KSD-023FRG	95147608	335844	Lmax : 20MM SHORT							
					95166267									
WINSTORM C105 MAX														
	LH	GAS	S	KSD-022FLG	95948811		REBOUND SPRING X							
					96858479									
	RH	GAS	S	KSD-022FRG	95948812									
					96858480									

RENAULT SAMSUNG

CAR NAME	FRONT							REAR							
	LH/RH/CM	GAS/OIL	TYPE	KIC FAC_NO	OE NO	KYB NO	REMARK	LH/RH/CM	GAS/OIL	TYPE	KIC FAC_NO	OE NO	KYB NO	REMARK	
SM3 N17															
	LH	GAS	S	KFR-001FLG	4421031030			CM	GAS	S-S	KFR-001RCG	4531031020		S-E	
					4421031700							4531031700			
	RH	GAS	S	KFR-001FRG	4422031030										
					4422031700										
SM3 L38 09-MY															
	LH	GAS	S	KFR-005FCG	543020034R			CM	GAS	S-S	KFR-005RCG	562102543R		E-E	
	RH	GAS	S	KFR-005FRG											
SM5 KPQ															
	LH	GAS	S	KFR-002FLG	4421151520			CM	GAS	S-S	KFR-002RCG	4531051535		S-E	
					4531051525										
	RH	GAS	S	KFR-002FRG	4422151520										
SM5 EX1															
	LH	GAS	S	KFR-003FLG	4421052700			CM	GAS	S-S	KFR-003RCG	4531052700		R-E	
	RH	GAS	S	KFR-003FRG	4422052700										
SM7 EX2															
	LH	GAS	S	KFR-004FLG	4421052010			CM	GAS	S-S	KFR-004RCG	4531052010		R-E	
					4531052130										
	RH	GAS	S	KFR-004FRG	4422052010										

HYUNDAI

KIA

DAEWOO
GM
CHEVROLET

RENAULT
SAMSUNG

SSANGYONG

TOYOTA
LEXUS

NISSAN

SUZUKI

MITSUBISHI

MAZDA

ISUZU

CHERY

BYD

GEELY

FIAT

CHRYSLER

OPEL

PEUGEOT





SSANGYONG

CAR NAME	FRONT							REAR						
	LH/RH/CM	GAS/OIL	TYPE	KIC FAC_NO	OE NO	KYB NO	REMARK	LH/RH/CM	GAS/OIL	TYPE	KIC FAC_NO	OE NO	KYB NO	REMARK
ISTANA														
95-03	CM	OIL	C	KSS-004FCO	6613203730		R-E	CM	OIL	C	KSS-004RCO	6613263300		E-E (COACH)
KORANDO KJ														
96-05	CM	GAS	C	KSS-001FCG	4430105400		R-E	CM	GAS	C	KSS-001RCG	4530105400		R-E
					4430106000							4530106000		
					4430106220							4530106200		
					4430106400							4530106220		
					4431006220							4530106400		
												4531006220		
MUSSO FJ														
93-98	CM	OIL	C	KSS-002FCO	4430105000		R-E	CM	OIL	C	KSS-002RCO	4530105000		R-E
					4430105002							4530105002		
					4430105003							4530105003		
					4431005210							4531005210		
		GAS	C	KSS-002FCG	4430105203	344309			GAS	C	KSS-002RCG	4530105203	344310	
					4430105204							4530105204		
												4530105205		
MUSSO P100 SPORTS														
02-06	CM	GAS	C	KSS-003FCG	4430107201		R-E	CM	GAS	C	KSS-003RCG	4530107201		R-E
					4431007210							4531007210		







TOYOTA_Lexus

CAR NAME	FRONT							REAR						
	LH/RH/CM	GAS/OIL	TYPE	KIC FAC_NO	OE NO	KYB NO	REMARK	LH/RH/CM	GAS/OIL	TYPE	KIC FAC_NO	OE NO	KYB NO	REMARK
AURION CSV40 06-MY														
06-12 CAMRY 06- ACV40 FOR ASIA MARKET(CM)	LH	GAS	S	KJT-008FLG	4852006451	339111		LH	GAS	S	KJT-008RLG	4854006361	339113	
					4852009G40							4854006360		
					4852006450							4854009610		
					4852006460							4854009690		
					4852009G41							4854009691		
					4852009G80									
	RH	GAS	S	KJT-008FRG	4851009N91	339110		RH	GAS	S	KJT-008RRG	4853006360	339112	
					4851006450							4853006361		
					4851006451							4853009610		
					4851006460							4853009L30		
					4851009N40							4853009L31		
					4851009P30							4853009Q30		
ALPHARD GGH20														
08-15 VELLFIRE(CM)	LH	GAS	S	KJT-029FLG	4852058120	335051		CM	GAS	C	KJT-029RCG	4853080472	349002	R-E
					4852059505							4853080475		
	RH	GAS	S	KJT-029FRG	4851058120	335050						4853058060		
					4851080416									
COROLLA AE100 92-MY														
92-97 ZZE111	LH	GAS	S	KJT-003FLG	4852012610	333115		LH	GAS	S	KJT-003RLG	4854002120	333117	
					4852012630							4854012510		
					4852012640							4854012520		
					4852012700							4854012720		
					4852012710							4854012730		
					4852012740							4854012830		
					4852012860							4854012890		
					4852019145							4854019095		
					4852012610D							4854019185		
					4852012630M							4854019205		
					4852012640B							4854019265		
					4852012640C							485401A020		
					4852012710D							485401A120		
					4852012740B							485401A170		
	RH	GAS	S	KJT-003FRG	4851002051	333114		RH	GAS	S	KJT-003RRG	4853002130	333116	
					4851002071							4853012570		
					4851012750							4853012580		
					4851012760							4853012770		
					4851012820							4853012790		
					4851012830							4853012810		
					4851012840							4853019645		
					4851012870							4853080003		
					4851019425							4853090009		
					4851012750M							485301A010		
					4851012760B							485301A180		
					4851012760C							485301A230		
					485101A100									
					485101A100F									
COROLLA ZZE121 01-MY														
01-	LH	GAS	S	KJT-011FLG	4852002140	333339		CM	GAS	S-S	KJT-011RCG	4853002170	341307	S-E
					4852009430	B3232TOKIKOJ						4853080512	U2980TOKIKOJ	
					4852002160							4853002190		
	RH	GAS	S	KJT-011FRG	4851009530	333338						4853009430		
					4851002140	B3232TOKIKOJ						4853002460		
					4851002160									

TOYOTA_LEXUS

CAR NAME	FRONT							REAR							
	LH/RH/CM	GAS/OIL	TYPE	KIC FAC_NO	OE NO	KYB NO	REMARK	LH/RH/CM	GAS/OIL	TYPE	KIC FAC_NO	OE NO	KYB NO	REMARK	
COROLLA ZRE141 07-MY															
08-COROLLA ALTIS_ZZE14# FOR ASIA(CM) (ASIA/INDIA) 	LH	GAS	S	KJT-010FLG	4852009P10	339176		CM	GAS	S-S	KJT-010RCG	4853002680	341448	S-E	
					4852002750	339301						4853002560	340018		
												4853002790			
	RH	GAS	S	KJT-010FRG	4851009W10	339175						4853002660			
					4851002750	339300					4853002820				
COROLLA NZE121 00-MY															
00-08 NZE124, ZZE123, ZZE124, CE121, BYD F3 (CM) 	LH	GAS	S	KJT-004FLG	4852002150	334324		CM	GAS	S-S	KJT-004RCG	4853002180	341322	S-E	
					4852002360							4853002480			
					4852009440							4853013060			
					4852019676							4853019635			
					4852019706							4853080029			
					4852019725							4853080031			
					4852019875							4853080033			
					4852019885							4853080046			
					4852019895							4853080048			
					4852029595							4853080050			
					485202B320							4853080052			
					4852080001							4853080092			
					4852080002							4853080094			
												4853080096			
	RH	GAS	S	KJT-004FRG	4851002150	334323						4853080147			
					4851002250							4853012A40			
					4851009540							4853012A60			
					485102B320							4853012B20			
				4851080016							485301A400				
				4851080019							485301A420				
				4851080026							485301A440				
				4851080029							485301A480				
				4851080030							485301A620				
				4851080058							485301A640				
				4851080091							485301A650				
				4851080095							48530557N				
COROLLA CE140 09-MY															
07/08- 							Undeveloped	CM	GAS	S-S	KJT-022RCG	4853012D90	341363	S-E	
												4853047040			
												4853002600			
												4853002600C			
												4853002650			
												4853002650B			
												4853002690			
												4853002700			
												4853002770			
												4853080442			
COROLLA NZE173 15-MY															
15/12-16/09 	LH	GAS	S	KJT-040FLG	4852082020	3340042								Undeveloped	
					4852002B90										
	RH	GAS	S	KJT-040FRG	4851082172	3340041									
					4851002B90										



TOYOTA_LEXUS

CAR NAME	FRONT							REAR						
	LH/RH/CM	GAS/OIL	TYPE	KIC FAC_NO	OE NO	KYB NO	REMARK	LH/RH/CM	GAS/OIL	TYPE	KIC FAC_NO	OE NO	KYB NO	REMARK
COROLLA NZE171 14-MY														
14/10- 	LH	GAS	S	KJT-035FLG	4852002C00A	3340042		CM	GAS	S-S	KJT-035RCG	4853002680	341448	S-E
					4852002B90							4853002C50		
					4852002B91							4853002C50A		[CM] ONLY RR
					4852002C01							4853002C51		
					4852002C10							4853002C60A		
					4852002C50							4853002C61		
					4852002C70							4853002C70A		
					4852002C71							4853002C71		
												4853002C80A		
												4853002C81		
	RH	GAS	S	KJT-035FRG	4851002B90	3340041								
				4851002B91										
				4851002C00A										
				4851002C01										
				4851002C10										
				4851002C51										
				4851002C71										
				4851002C90										
CROWN S180														
08-12 	LH	GAS	S-S	KJT-018FLG	4852030251		S-E	CM	GAS	S-S	KJT-018RCG	4853030510		S-E
					4852080278							4853080471		
	RH	GAS	S-S	KJT-018FRG	4851030801									
				4851080556										
CRESSIDA RC80														
88-92 MARK2_X90(CM) 							Undeveloped	CM	GAS	S-S	KJT-030RCG	4853022043	341111	S-E
												4853022043		
												4853022091		
												4853029066		
												4853029165		
COROLLA ZRE152 09-MY														
07/03- 	LH	GAS	S	KJT-019FLG	4852012A41	339701								
					4852002380	339067								
	RH	GAS	S	KJT-019FRG	4851012B41	339700								
					4851002380	339066								
CAMRY ACV40 06-MY														
06- 	LH	GAS	S	KJT-013FLG	4852009D50	339024		LH	GAS	S	KJT-013RLG	4854009590		AVALON PART NO
					4852080090									
					4852033590									
RH	GAS	S	KJT-013FRG	4851080308	339023		RH	GAS	S	KJT-013RRG	4853009D60		AVALON PART NO	
				4851080309										
				4851033590										
CAMRY AVV50 12-MY														
12- 	LH	GAS	S	KJT-037FLG	4852033650	339352		LH	GAS	S	KJT-037RLG	4854033460	339026	
					4852033640							4854006330		
					4852006710							4854006330C		
					4852006710A							4854006490		
	RH	GAS	S	KJT-037FRG	4851033650	339351		RH	GAS	S	KJT-037RRG	4853033460	339025	
				4851033640							4853006330			
				4851006720							4853006330C			
				4851006740							4853006490			

TOYOTA_LEXUS







CAR NAME	FRONT						REAR							
	LH/RH/CM	GAS/OIL	TYPE	KIC FAC_NO	OE NO	KYB NO	REMARK	LH/RH/CM	GAS/OIL	TYPE	KIC FAC_NO	OE NO	KYB NO	REMARK
PRIUS NHW20 04-MY														
	04-09	LH	GAS	S	KJT-016FLG	4852047040	333389		CM	GAS	S-S	KJT-016RRG	4853047031	R-E
						4852047041							4853047030	
						4852047050							4853049385	
						4852048575							4853049695	
						4852049585								
						4852080064								
		RH	GAS	S	KJT-016FRG	4851047041	333388							
						4851047040								
						4851047050								
						4851049495								
						4851049505								
						4851049665								
						4851080274								
	PRIUS ZVW30 09-MY													
	09-12	LH	GAS	S	KJT-017FLG	4852047181	339243		CM	GAS	C	KJT-017-RCG	4853047091	349035 R-E
						4852047090							4853080499	
						4852047110							4853080533	
						4852080228								
		RH	GAS	S	KJT-017FRG	4851047181	339242							
						4851047090								
						4851047110								
					4585180488									
RAV4 XA30														
	05-12	LH	GAS	S	KJT-015FLG	4852080341			CM	GAS	C	KJT-015RCG	4853142130	349024
		RH	GAS	S	KJT-015FRG	4851080638								
WINDOM MCV21														
	96-01	LH	GAS	S	KJT-007FLG	4852039405	339087		LH	GAS	S	KJT-007RLG	4854033090	334479
						4852033250							4854033160	
						4852033280							4854039155	
						4852039166							4854039195	
						4852039255							4854039225	
						48520AA020							4854039236	
						4852039365							4854039246	
						4852039375							4854039295	
						48520A9020							4854039355	
						48520A9010							4854039375	
						48520AA010								
						4852033370								
		RH	GAS	S	KJT-007FRG	4851033250	339086		RH	GAS	S	KJT-007RRG	4853006081	334478
						4851033280							4853006091	
						4851039486							4853006170	
						4851039615							4853007080	
						4851039815							4853009070	
						4851039825							4853033090	
						48510A9010							4853033160	
					48510A9020							4853033190		
					48510AA010							4853039205		
					48510AA020							4853038205		
					4851080013							4853039245		
												4853039275		

TOYOTA_LEXUS



CAR NAME	FRONT						REAR							
	LH/RH/CM	GAS/OIL	TYPE	KIC FAC_NO	OE NO	KYB NO	REMARK	LH/RH/CM	GAS/OIL	TYPE	KIC FAC_NO	OE NO	KYB NO	REMARK
SAI AZK10														
	13-	LH	GAS	S	KJT-038FLG	4852075010	3350041		CM	GAS	C	KJT-038RCG	4853075020	3440093
						4852075070							4853075020A	
						4852075140							4853075070	
						4852079045							4853075080	
						4852079405							4853075090	
													4853074100	
		RH	GAS	S	KJT-038FRG	4851079010	3350040						4853045160	
						4851075070							4853079255	
						4851075140								
						4851079042								
					4851079395									
IS GXE10														
	99-	CM	GAS	S-S	KJT-033FCG	4851053010	341262	S-E						Undeveloped
						4851053020								
						4851053030								
						4851053040								
						4851059315								
						4851059325								
					4851080004									
					4851080005									
RX450 AL10														
	10-	LH	GAS	S	KJT-020FLG	1A13023-B	339282		CM	GAS	S	KJT-020RCG	1A13717E	349203
						4852080208							4853148110	
						48520A9500							4853148200	
						4852080209							1A13588E	
						48520A9520								
						4852080303								
						1A13592F								
						1A13594F								
						1A15617F								
		RH	GAS	S	KJT-020FRG	1A13023-A	339281							
						4851080467								
						48510A9800								
						4851080468								
						4851080471								
					48510A9820									
					4851080583									
					1A13592E									
					1A13594E									
					1A15617E									

HYUNDAI
KIA
DAEWOO GM CHEVROLET
RENAULT SAMSUNG
SSANGYONG
TOYOTA LEXUS
NISSAN
SUZUKI
MITSUBISHI
MAZDA
ISUZU
CHERY
BYD
GEELY
FIAT
CHRYSLER
OPEL
PEUGEOT

NISSAN



CAR NAME	FRONT							REAR							
	LH/RH/CM	GAS/OIL	TYPE	KIC FAC_NO	OE NO	KYB NO	REMARK	LH/RH/CM	GAS/OIL	TYPE	KIC FAC_NO	OE NO	KYB NO	REMARK	
ALMERA N15 98-MY															
	98-	LH	GAS	S	KJN-005FLG	543034M426	332117		CM	GAS	S-S	KJN-005RCG	562104M426	341279	S-E SUNNY_N16[CM]
	RH	GAS	S	KJN-005FRG	543024M426	332116									
DATSUN D40T															
	07-	CM	GAS	S-S	KJN-006FCG	56110EB70B E6110EB70B	U3814	S-E							Undeveloped
LIVINA L10Z GENISS															
	06-	LH	GAS	S	KJN-007FLG	54303CJ40C 54303CJ41C	333391								Undeveloped
	RH	GAS	S	KJN-007FRG	54302CJ40C 54302CJ41C	333390									
MAXIMA A33 00-MY															
	98-02 CEFIRO3 SALOON 01-09[CM]	LH	GAS	S	KJN-004FLG	543032Y905 543032Y987 543032Y988 543032Y989 543036Y300 543036Y325 543036Y400 543036Y425	334367		CM	GAS	S-S	KJN-004RCG	562102Y403 562105Y000 562105Y025 562106Y000 562106Y300 562106Y325 562106Y401 562106Y425 562106Y427	341341	S-E
	RH	GAS	S	KJN-004FRG	543022Y904 543022Y987 543022Y988 543022Y989 543026Y300 543026Y325 543026Y400 543026Y425	334366									
NAVARA GD21 2WD															
	85-98 2WD	CM	OIL	C	KJN-008FCO	5611025G00 5611025G25 5611025G26 5611025G27 5611025G50 5611025G85	443238		CM	OIL	C	KJN-008RCO	5621025G00 5621025G25 5621025G26 5621025G27	443226	
TIIDA C11															
	05-08	LH	GAS	S	KJN-002FLG	E4C03EE90A E4303EE90A 54303ED001 E4303CJ41C	B2322[TOKIKO]								Undeveloped
	RH	GAS	S	KJN-002FRG	E4C02EE90A E4302EE90A 54302ED001 E4302CJ41C	B2322[TOKIKO]									

NISSAN



CAR NAME	FRONT							REAR							
	LH/RH/CM	GAS/OIL	TYPE	KIC FAC_NO	OE NO	KYB NO	REMARK	LH/RH/CM	GAS/OIL	TYPE	KIC FAC_NO	OE NO	KYB NO	REMARK	
SUNNY N16 00-MY															
	01-10 ALMERA(N16) 00-01[CM]	LH	GAS	S	KJN-001FLG	543036N100 543036N125 543036N1X5 543036N200 543036N225 543036N2X5 54303BM418 54303BM485 54303BN424	333311		CM	GAS	S-S	KJN-001RCG	562104M400 562104M405 562104M425 562104Z000 562104Z005 562104Z025 562104Z027 562104Z600 562104Z625 562105M400	341279	S-E ALMERA_N15[CM]
	RH	GAS	S	KJN-001FRG	543026N100 543026N125 543026N1X5 543026N200 543026N225 543026N2X5 54302BM418 54302BN421 54302BN424 54302BN425 54302BN428	333310						562105M425 562108M400 562108M600			
VERSA C12															
	12-15	LH	GAS	S	KJN-003FLG	E43033AN0C 543033AN0C	332153		CM	GAS	C	KJN-003RCG	562101HJ1A 5621003AN0C E62103AN0C	348029	R-E
	RH	GAS	S	KJN-003FRG	E43023AN0C 543023AN0C	332152									

- HYUNDAI
- KIA
- DAEWOO
GM
CHEVROLET
- RENAULT
SAMSUNG
- SSANGYONG
- TOYOTA
LEXUS
- NISSAN**
- SUZUKI
- MITSUBISHI
- MAZDA
- ISUZU
- CHERY
- BYD
- GEELY
- FIAT
- CHRYSLER
- OPEL
- PEUGEOT

SUZUKI





CAR NAME	FRONT							REAR						
	LH/RH/CM	GAS/OIL	TYPE	KIC FAC_NO	OE NO	KYB NO	REMARK	LH/RH/CM	GAS/OIL	TYPE	KIC FAC_NO	OE NO	KYB NO	REMARK
ALTO HA11														
	LH	GAS	S	KJS-002FLG	NST8006L			CM	GAS	C	KJS-002RCG	NSG8006A		E-E
	RH	GAS	S	KJS-002FRG	NST8006R									
CAPPUCCINO EA11														
	CM	GAS	S-S	KJS-003FCG	NSF9027		S-E	CM	GAS	S-S	KJS-003RCG	NSF9028		S-F
SWIFT FZ82														
11- 	LH	GAS	S	KJS-004FLG	4160258M00	338095		CM	GAS	C	KJS-004RCG	4181058M00	384084	E-E
					4160258M20							4181058M20		
					4160271L00							4181070L01		
					4160271L20							4181071L00		
												4181071L20		
	RH	GAS	S	KJS-004FRG	4160158M00	338094						7181071L22		
					4160158M20									
					4160171L00									
					4160171L20									
SWIFT RS413														
05- 	LH	GAS	S	KJS-005FLG	4106977J10	333426		CM	GAS	C	KJS-005RCG	4180063J00	343464	E-E
					4106977J20							4180063J01		
					4160263J10						4180063J02			
					4160263J11						4181063J00			
					4160263J12						4181063J01			
											4181063J02			
	RH	GAS	S	KJS-005FRG	4106877J10	333425						4188077J00		
					4106877J20									
					4160163J10									
					4160163J11									
					4160163J12									
WAGON R C11														
	LH	GAS	S	KJS-001FLG	NST5180L			CM	GAS	C	KJS-001RCG	NSF1031		E-E
	RH	GAS	S	KJS-001FRG	NST5180R									

MITSUBISHI

CAR NAME	FRONT							REAR						
	LH/RH/CM	GAS/OIL	TYPE	KIC FAC_NO	OE NO	KYB NO	REMARK	LH/RH/CM	GAS/OIL	TYPE	KIC FAC_NO	OE NO	KYB NO	REMARK
LANCER CS1A 1300														
92-09 	CM	GAS	S	KJMI-001FCG	MR519614	333381		CM	GAS	S-S	KJMI-001RCG	MR519613	341318	S-E
													U20017	
LANCER CB2A KRESTALA														
96-01 CJ,CK,CM KRESTALA (FOR EGYPT) 	LH	GAS	S	KJMI-003FLG	MR316070	333289		CM	GAS	S-S	KJMI-003RCG	30618110	341145	S-E
					SW604189							MB891463		
					SW604063						MB891464			
											SW604061			
	RH	GAS	S	KJMI-003FRG	MR316069	333288								
					SW604188									
					SW604062									
LANCER CS9A ESTATE														
03- LANCER SALOON 03-07(CM) 	CM	GAS	S	KJMI-005FCG	4060A320	334420		CM	GAS	S-S	KJMI-005RCG	4162A184	341368	S-E
					MN101957							MN100077		
					MR589639						MN100090			
											MN101601			
											MR554528			
											MR491956			
											MR589972			
LANCER CY2A C9														
07- 	LH	GAS	S	KJMI-007FLG	4060A242	339118		CM	GAS	S-S	KJMI-007RCG	4162A036	341444	S-E
	RH	GAS	S	KJMI-007FRG	4060A241	339117						4162A130		
L200 L021P														
78- 	CM	OIL	C	KJMI-009FCG	MB109561	443189	R-E(X-PIN)							Undeveloped
L200 KA5T 05-MY														
05- 	CM	GAS	S-S	KJMI-004FCG	MR992321	340033	S-E							Undeveloped
					MR992320	5510002								
					4062A031									
					4062A082									
					4062A099									
OUTLANDER CW5W														
06- OUTLANDER2 (CW) 	LH	GAS	S	KJMI-006FLG	4060A173	339081		CM	GAS	C	KJMI-006RCG	4162A050	349040	R-E
	RH	GAS	S	KJMI-006FRG	4060A174	339080								
PAJERO V64W														
04-06 	CM	GAS	S-S	KJMI-008FCG	4062A002	341445	S-E	CM	GAS	C	KJMI-008RCG	MR418049	344300	R-E
					4062A003							MR554291		
					4062A005						MR554330			
					4062A006						MR566275			
					4062A023						MR566276			
					4062A024						4162A016			
											4162A023			

- HYUNDAI
- KIA
- DAEWOO
GM
CHEVROLET
- RENAULT
SAMSUNG
- SSANGYONG
- TOYOTA
LEXUS
- NISSAN
- SUZUKI**
- MITSUBISHI**
- MAZDA
- ISUZU
- CHERY
- BYD
- GEELY
- FIAT
- CHRYSLER
- OPEL
- PEUGEOT

MAZDA

CAR NAME	FRONT							REAR						
	LH/RH/CM	GAS/OIL	TYPE	KIC FAC_NO	OE NO	KYB NO	REMARK	LH/RH/CM	GAS/OIL	TYPE	KIC FAC_NO	OE NO	KYB NO	REMARK
MAZDA2 DE DEMIO														
11-14	LH	GAS	S	KJM-001FLG	DR61-34-900B	333495		CM	GAS	C	KJM-001RCG	D04A-28-70XE	553379	R-E
	RH	GAS	S	KJM-001FRG	DR61-34-700B	333494								
MAZDA3 BK SPEED														
03-	LH	GAS	S	KJM-002FLG	B37F-34-900	334701		CM	GAS	C	KJM-002RCG	BBN5-28-910C	343412	R-E
					B37F-34-900A							BRY0-28-910		
					B37F-34-900B									
					BRY0-34-900									
	RH	GAS	S	KJM-002FRG	B37F-34-700	334700								
					B37F-34-700A									
					B37F-34-700B									
					BRY0-34-700									
MAZDA3 BM 14-MY														
14-	LH	GAS	S	KJM-003FLG	BHP7-34-900	3340036		CM	GAS	C	KJM-003RCG	BHN2-28-700A	3430041	R-E
					B45L-34-900							BHN2-28-910B		
					B54G-34-900							BHN9-28-700A		
					B60P-34-900							BJM5-28-910A		
					B60P-34-900A							BJT6-28-700D		
					BHS2-34-900							BKC6-28-910A		
					BHS2-34-900A							BKC6-28-910B		
												B45L-28-910A		
	RH	GAS	S	KJM-003FRG	BHP7-34-700	3340035						B60P-28-700A		
					B45L-34-700							B60P-28-910B		
					B54G-34-700									
					B60P-34-700									
					B60P-34-700A									
					BHS2-34-700									
					BHS2-34-700A									
MAZDA6 GJ 12-MY														
12-	LH	GAS	S	KJM-004FLG	GJR9-34-900	339405		CM	GAS	C	KJM-004RCG	GJR9-28-700B	349246	R-E
					GJR9-34-900B							GJR9-28-700C		
					GJR9-34-900C							GJR9-28-700D		
					GJR9-34-900D							GJR9-28-700E		
	RH	GAS	S	KJM-004FRG	GJR9-34-700	339404								
					GJR9-34-700B									
					GJR9-34-700C									
					GJR9-34-700D									
MAZDA 323 BG 89-MY														
89-94	LH	OIL	S	KJM-006FLO	BR70-34-900D	633138		LH	GAS	S	KJM-006RLG	BR70-28-900A	333133	
					BR70-34-900	333127(GAS)						BB1P-28-900A	633144(OIL)	
					B4553-34-900D									
					B459-34-900D									
	RH	OIL	S	KJM-006FRO	BR70-34-700D	633137		RH	GAS	S	KJM-006RRG	BR70-28-700D	333132	
					BR70-34-700	333126(GAS)						BB1P-28-700A	633143(OIL)	
					B4553-34-700D									
					B459-34-700D									



MAZDA

CAR NAME	FRONT							REAR						
	LH/RH/CM	GAS/OIL	TYPE	KIC FAC_NO	OE NO	KYB NO	REMARK	LH/RH/CM	GAS/OIL	TYPE	KIC FAC_NO	OE NO	KYB NO	REMARK
MAZDA 323 BJ 98-MY														
98-00	LH	GAS	S	KJM-007FLG	B26R-34-900	333275		LH	GAS	S	KJM-007RLG	BK2J-28-700E	333296	
					B25D-34-900C									
					B25T-34-900C									
					BJ3D-34-900C									
					BK2H-34-900A									
	RH	GAS	S	KJM-007FRG	B26R-34-700	333274		RH	GAS	S	KJM-007RRG	BK2J-28-900E	333297	
					B25D-34-700C									
					B25T-34-700C									
					BJ3D-34-700C									
					BK2H-34-700A									
MAZDA 323 BJ 00-MY														
00-03	LH	GAS	S	KJM-008FLG	B30D-34-900C	333351								Undeveloped
					B25T-34-900D									
					B26R-34-900D									
					B26R-34-900E									
					BJ3D-34-900E									
	RH	GAS	S	KJM-008FRG	B30D-34-700C	333350								
					B25T-34-700D									
					B26R-34-700D									
					B26R-34-700E									
					BJ3D-34-700E									
MAZDA 626 CAPELLA GF														
97-02	LH	GAS	S	KJM-009FLG	GE6V-34-900	334200		LH	GAS	S	KJM-009RLG	GE4T-28-900A	334202	
					G14F-34-900A							GE4V-28-900A		
					GE4V-34-900A									
	RH	GAS	S	KJM-009FRG	GE6V-34-700	334199		RH	GAS	S	KJM-009RRG	GE4T-28-700A	334201	
					G14F-34-700A							GE4V-28-700A		
					GE4V-34-700A									
MAZDA PREMACY CP														
99-01	LH	GAS	S	KJM-005FLG	C100-34-900B	333269								Undeveloped
					C100-34-900									
	RH	GAS	S	KJM-005FRG	C100-34-700B	333268								
					C100-34-700									

ISUZU

CAR NAME	FRONT							REAR						
	LH/RH/CM	GAS/OIL	TYPE	KIC FAC_NO	OE NO	KYB NO	REMARK	LH/RH/CM	GAS/OIL	TYPE	KIC FAC_NO	OE NO	KYB NO	REMARK
DMAX RA 4WD														
11- 	CM	GAS	S-S	KJI-001FCG	8979470973	340107	S-E							Undeveloped
					8979470983									
					8979470994									
					8981619152									

CHERY

CAR NAME	FRONT							REAR						
	LH/RH/CM	GAS/OIL	TYPE	KIC FAC_NO	OE NO	KYB NO	REMARK	LH/RH/CM	GAS/OIL	TYPE	KIC FAC_NO	OE NO	KYB NO	REMARK
CHERY A5														
06- ELARA A21 	CM	GAS	S	KCC-001FCG	2905010									
					A21-2905010									
CHERY A113														
06- 	CM	GAS	S	KCC-002FCG	S12-2905010			CM	OIL	C	KCC-002RCO	S12-2915010		E-E
CHERY TIGGO														
06- 	LH	GAS	S	KCC-003FLG	T11-2905010			CM	GAS	C	KCC-003RCG	T11-2915010		R-E
	RH	GAS	S	KCC-003FRG	T11-2905020									

HYUNDAI
KIA
DAEWOO GM CHEVROLET
RENAULT SAMSUNG
SSANGYONG
TOYOTA LEXUS
NISSAN
SUZUKI
MITSUBISHI
MAZDA
ISUZU
CHERY
BYD
GEELY
FIAT
CHRYSLER
OPEL
PEUGEOT

BYD





CAR NAME	FRONT							REAR						
	LH/RH/CM	GAS/OIL	TYPE	KIC FAC_NO	OE NO	KYB NO	REMARK	LH/RH/CM	GAS/OIL	TYPE	KIC FAC_NO	OE NO	KYB NO	REMARK
BYD F3														
05-COROLLA 00_NZE121(CM)	LH	GAS	S	KCB-001FLG	F3-2905010	334324		CM	GAS	S-S	KCB-001RCG	F3-2915010	341322	S-E
	RH	GAS	S	KCB-001FRG	F3-2905020	334323								

GEELY

CAR NAME	FRONT							REAR						
	LH/RH/CM	GAS/OIL	TYPE	KIC FAC_NO	OE NO	KYB NO	REMARK	LH/RH/CM	GAS/OIL	TYPE	KIC FAC_NO	OE NO	KYB NO	REMARK
EMGRAND EC7														
09-14 COROLLA 00_NZE121(CM)	LH	GAS	S	KGG-001FLG	1064001256			CM	GAS	S-S	KGG-001RCG	1064001268		S-E
	RH	GAS	S	KGG-001FRG	1064001257									

- HYUNDAI
- KIA
- DAEWOO GM CHEVROLET
- RENAULT SAMSUNG
- SSANGYONG
- TOYOTA LEXUS
- NISSAN
- SUZUKI
- MITSUBISHI
- MAZDA
- ISUZU
- CHERY
- BYD**
- GEELY**
- FIAT
- CHRYSLER
- OPEL
- PEUGEOT

FIAT

CAR NAME	FRONT							REAR						
	LH/RH/CM	GAS/OIL	TYPE	KIC FAC_NO	OE NO	KYB NO	REMARK	LH/RH/CM	GAS/OIL	TYPE	KIC FAC_NO	OE NO	KYB NO	REMARK
FIAT 127														
71-74	CM	OIL	S	KIF-001FCO	1762			CM	OIL	S	KIF-001RCO	594712		
					4383008							4256650		
FIAT 128														
69-85	CM	OIL	S	KIF-002FCO	594719			CM	OIL	S	KIF-002RCO	594713		
					4408215							4408218		
FIAT 131														
74-84	CM	OIL	S	KIF-003FCO	11501									
					4418700									
FIAT 132														
72-81	CM	OIL	C	KIF-004FCO	293329	443013	R-E	CM	OIL	C	KIF-004RCO	294631		R-E
					4325450							4285686		

CHRYSLER

CAR NAME	FRONT							REAR						
	LH/RH/CM	GAS/OIL	TYPE	KIC FAC_NO	OE NO	KYB NO	REMARK	LH/RH/CM	GAS/OIL	TYPE	KIC FAC_NO	OE NO	KYB NO	REMARK
CHRYSLER 300 LX														
11-	LH	GAS	S	KUCH-001FLG	68072065AE		SAME AS							
							DODGE							
							CHARGER							
	RH	GAS	S	KUCH-001FRG	68072064AE		[2011-2018]							

HYUNDAI

KIA

DAEWOO
GM
CHEVROLET

RENAULT
SAMSUNG

SSANGYONG

TOYOTA
LEXUS

NISSAN

SUZUKI

MITSUBISHI

MAZDA

ISUZU

CHERY

BYD

GEELY



FIAT

CHRYSLER



OPEL

PEUGEOT

OPEL

CAR NAME	FRONT							REAR						
	LH/RH/CM	GAS/OIL	TYPE	KIC FAC_NO	OE NO	KYB NO	REMARK	LH/RH/CM	GAS/OIL	TYPE	KIC FAC_NO	OE NO	KYB NO	REMARK
ASTRA T91														
91-98	CM	OIL	C	KGO-001FCO	32A710	365504	R-C	CM	OIL	C	KGO-001RCO	27D56A	343099	R-E
					A-8102H							A-1706H		
					90236798							90272379		
					90443129									
ASTRA T98														
98-04							Undeveloped	CM	OIL	C	KGO-002RCO	A-1258G	343307	E-E
												93172195		
CORSA S83														
93-	CM	OIL	S	KGO-003FCO	A-3602H	323034		CM	OIL	C	KGO-003RCO	A-1603H		R-E
					90009929							90166772		
VECTRA J89														
88-95	CM	OIL	C	KGO-004FCO	115007	365503	R-C							Undeveloped
					90236796							A-8734G		

PEUGEOT

CAR NAME	FRONT							REAR						
	LH/RH/CM	GAS/OIL	TYPE	KIC FAC_NO	OE NO	KYB NO	REMARK	LH/RH/CM	GAS/OIL	TYPE	KIC FAC_NO	OE NO	KYB NO	REMARK
PEUGEOT 206														
SALOON 07-	LH	GAS	S	KFP-001FLG	5202AX	333730		CM	GAS	C	KFP-001RCG	5206Q4	341249	
														
	RH	GAS	S	KFP-001FRG	5202AY	333729								
PEUGEOT 405														
	CM	GAS	S	KFP-002FCG	520204	333829								
														

HYUNDAI

KIA

DAEWOO
GM
CHEVROLET

RENAULT
SAMSUNG

SSANGYONG

TOYOTA
LEXUS

NISSAN

SUZUKI

MITSUBISHI

MAZDA

ISUZU

CHERY

BYD

GEELY

FIAT

CHRYSLER

OPEL

PEUGEOT

COMPATIBLE PRODUCT INDEX

KIC Expands supply of supreme quality Shock Absorber to the global market.

- 67 HYUNDAI
- 81 KIA
- 91 DAEWOO/GM/CHEVROLET
- 98 RENAULT SAMSUNG
- 99 SSANGYONG
- 100 TOYOTA-LEXUS
- 108 NISSAN
- 110 SUZUKI
- 111 MITSUBISHI
- 112 MAZDA
- 114 ISUZU
- 115 CHERY
- 116 BYD
- 117 GEELY
- 118 FIAT
- 119 CHRYSLER
- 120 OPEL
- 121 PEUGEOT

HYUNDAI

COMPATIBLE NO LIST

MODEL	FRT/RR	LH/RH/L/R	KIC	KYBI GAS	KYBI OIL	OE NO		
ATOZ MX	FRT	LH	KSH-007FLO	333257	633205	54650-02000		
						54650-02020		
						54650-02021		
						54650-02100		
						54650-02120		
						54650-02121		
						54650-02210		
						54650-02220		
						54650-02221		
						54650-02310		
						54650-02320		
						54650-02321		
						54650-02410		
						54650-02420		
						54650-02421		
						54650-02510		
						54650-02520		
						ATOZ MX	FRT	RH
54660-02020								
54660-02021								
54660-02100								
54660-02120								
54660-02121								
54660-02210								
54660-02220								
54660-02221								
54660-02310								
54660-02320								
54660-02321								
54660-02410								
54660-02420								
54660-02421								
54660-02510								
54660-02520								
ATOZ MX	RR	L/R	KSH-007RCO	343301	443300			
						55310-02010		
						55310-02011		
						55310-02110		
						55310-02111		
						55310-02110		
ACCENT X3	FRT	LH	KSH-001FLO	333212	633178	54650-22000		
						54651-22000		
						54651-22100		
						54651-22102		
						54651-22200		
						54651-22201		
						54651-22300		
						54651-22350		
						54651-22450		
						54651-22900		
						54651-22901		
						54651-22902		
						54651-22950		
						54651-22951		
						54651-22952		
						54650-22000		
						54651-22000		
						54651-22100		
		54651-22102						
		54651-22200						
		54651-22201						
		54651-22300						
		54651-22350						
		54651-22450						
		54651-22900						
		54651-22901						
		54651-22902						
		54651-22950						
		54651-22951						
		54651-22952						
		ACCENT X3	FRT	RH	KSH-001FLO	333212	633178	54650-22000
								54651-22000
								54651-22100
								54651-22102
								54651-22200
								54651-22201
54651-22300								
54651-22350								
54651-22450								
54651-22900								
54651-22901								
54651-22902								
54651-22950								
54651-22951								
54651-22952								
54650-22000								
54651-22000								

MODEL	FRT/RR	LH/RH/L/R	KIC	KYBI GAS	KYBI OIL	OE NO		
ACCENT X3 94-MY	RR	LH	KSH-003RLO	33208	632104	55350-22000		
						55351-22000		
						55351-22050		
						55351-22051		
						55351-22100		
						55351-22150		
						55351-22151		
						55351-22200		
						55351-22250		
						55351-22300		
						55351-22350		
						55351-22400		
						55351-22450		
						55351-22500		
						55351-22600		
						55351-22650		
						55351-22900		
						55351-22901		
		55351-22950						
		55351-22951						
		ACCENT X3 97-MY	RR	RH	KSH-003RRO	332080	632103	55360-22000
								55361-22000
								55361-22050
								55361-22051
								55361-22100
								55361-22150
								55361-22151
								55361-22200
								55361-22250
								55361-22300
								55361-22350
								55361-22400
								55361-22450
55361-22500								
55361-22600								
55361-22650								
55361-22900								
55361-22901								
55361-22950								
55361-22951								
55351-22102								
55351-22152								
55351-22651								
55351-22652								
55351-22902								
55351-22910								
55351-22952								
55351-22960								
55351-25000								
55351-25050								
55351-25051								
55361-22102								
55361-22152								
55361-22651								
55361-22652								
55361-22902								
55361-22910								
55361-22952								
55361-22960								
55361-25000								
55361-25050								
55361-25051								

MODEL	FRT/RR	LH/RH/L/R	KIC	KYBI GAS	KYBI OIL	OE NO	
ACCENT RB	FRT	LH	KSH-026FLG	338107 G7422 (MONROE)		54650-1R000	
						54650-1R001	
						54650-1R401	
						54650-1R061	
						54650-1R100	
						54650-1R101	
						54650-1R200	
						54650-1R201	
						54650-1R300	
	RR	L/R	KSH-026RCG	349098		54651-4L000	
						54660-1R000	
						54660-1R001	
						54660-1R061	
						54660-1R100	
						54660-1R101	
						54660-1R200	
						54660-1R201	
						54660-1R300	
ACCENT HC	FRT	LH	KSH-061FLG			54650-H6200	
	RR	RH	KSH-061FRG			54660-H6200	
		L/R	KSH-061RCG			55310-H6200	
AVANTE RD	FRT	LH	KSH-010FLO		333206	54651-29000	
						54651-29002	
						54651-29003	
						54651-29050	
						54651-29053	
						54651-29100	
						54651-29102	
						54651-29103	
						54651-29132	
			KSH-010FLG			54651-29133	
						54651-29150	
						54651-29153	
						54651-29600	
						54651-29610	
						54651-29650	
						54661-29000	
						54661-29002	
						54661-29003	
	RR	LH	KSH-010FRO		333205	54661-29050	
						54661-29053	
						54661-29100	
						54661-29102	
						54661-29103	
						54661-29132	
						54661-29133	
						54661-29150	
						54661-29153	
			KSH-010FRG				54661-29600
							54661-29610
							54661-29650
							55351-29000
							55351-29051
							55351-29053
KSH-010RLO				55351-29055			
				55351-29100			
				55351-29151			
				55351-29155			
				55351-29156			
				55351-29600			
				55351-29610			
				55351-29650			
				55351-29000			
				55351-29051			
				55351-29053			
				55351-29055			
KSH-010RLG				55351-29100			
				55351-29151			
				55351-29155			
				55351-29156			
				55351-29600			
				55351-29610			

MODEL	FRT/RR	LH/RH/L/R	KIC	KYBI GAS	KYBI OIL	OE NO	
AVANTE RD	RR	RH	KSH-010RRO		333207	55361-29000	
						55361-29051	
						55361-29053	
						55361-29055	
						55361-29100	
						55361-29151	
						55361-29155	
						55361-29156	
						55361-29600	
						55361-29610	
AVANTE XD	FRT	LH	KSH-011FLG	333206		54651-2D000	
		RH	KSH-011FRG	333205		54651-2D100	
	RR	LH	KSH-011RLG	333501		54661-2D000	
		RH	KSH-011RRG	333500		54661-2D100	
	AVANTE HD	FRT	LH	KSH-008FLG	338023		55351-2D000
			RH	KSH-008FRG	338022		55351-2D100
		RR	L/R	KSH-008RCG	349085		54651-2H000
							54651-2H100
	AVANTE MD	FRT	LH	KSH-009FLG	333519 3330049 G7404 (MONROE)		54651-2H000
							54651-2H100
54651-2H100							
54651-2H100							
55300-2H000							
55311-2H000							
55311-2H100							
55311-2H101							
55311-2H201							
54651-3X000							
AVANTE MD	FRT	RH	KSH-009FRG	333518 3330048 G7403 (MONROE)		54651-3X050	
						54651-3X051	
						54651-3X150	
						54651-3X151	
						54651-3X160	
						54651-3X250	
						54651-3X251	
						54651-3X260	
						54651-3X350	
						54651-3X351	
AVANTE MD	RR	L/R	KSH-009RCG	349184		54651-3X250	
						54651-3X251	
						54651-3X260	
						54651-3X350	
						54651-3X351	
						54651-3X360	
						55300-3X000	
						55300-3X100	
						55300-3X110	
						55300-3X150	
AVANTE MD	RR	L/R	KSH-009RCG	349184		55300-3X200	
						55300-3X210	
						55300-3X220	
						55300-3X400	
						55300-A5700	
						55310-3X200	

MODEL	FRT/RR	LH/RH/L/R	KIC	KYBI GAS	KYBI OIL	OE NO	
AVANTE AD	FRT	LH	KSH-048FLG			54651-F2000	
						54651-F2010	
						54651-F2020	
						54651-F2500	
						54651-F2510	
	RR	L/R	KSH-048RCG			54651-F2BA0	
						54661-F2000	
						54661-F2010	
						54661-F2020	
						54661-F2500	
CLICK TB	FRT	LH	KSH-012FLG	333507		54661-F2510	
						54661-F2BA0	
						55310-F2000	
						55307-F2520	
						55310-F2500	
	RR	L/R	KSH-012RCG			55310-F2710	
						54650-1C000	
						54650-1C050	
						54650-1C100	
						54650-1C150	
CRETA GS	FRT	RH	KSH-012FRG	333506		54650-1C200	
						54650-1C300	
						54660-1C000	
						54660-1C050	
						54660-1C100	
	RR	L/R	KSH-012RCG			54660-1C150	
						54660-1C200	
						54660-1C300	
						55310-1C000	
						55310-1C200	
EXCEL X2	FRT	LH	KSH-037FLG			55310-1C500	
						54650-C9000	
						54650-C9100	
						54651-A0100	
						54651-A1000	
	RR	L/R	KSH-037RCG			54651-M0000	
						54660-C9000	
						54660-C9100	
						54661-A0100	
						54661-A1000	
ELANTRA J1	FRT	L/R	KSH-014FCO			54661-M0000	
						55300-C9000	
						55310-C9000	
						55310-M0000	
						54300-46050	
	RR	L/R	KSH-015FCO	333156 (GAS)	633150		54650-24000
							54650-24110
							54650-24120
							54650-24300
							54650-24400
ELANTRA J1	FRT	L/R	KSH-014FCG	334088		55310-24000	
						55310-24152	
						55310-24400	
						55310-24450	
						55310-24452	
	RR	L/R	KSH-015RCO	343183 (GAS)	443269		54650-28012
							54650-28102
							54650-28202
							54650-28221
							54650-28201
ELANTRA J1	FRT	L/R	KSH-014FCG	334088		54650-28512	
						54650-28511	
						54650-28521	

MODEL	FRT/RR	LH/RH/L/R	KIC	KYBI GAS	KYBI OIL	OE NO			
ELANTRA J1	RR	L/R	KSH-014RCO		441091	55310-28000			
						55310-28011			
						55310-28100			
						55310-28101			
						55310-28202			
			KSH-014RCG			55310-28221			
						55310-28510			
						55310-28512			
						55310-28521			
						55310-28600			
EON HA	FRT	LH	KSH-038FLG			54650-4N000			
		RH	KSH-038FRG			54650-4N050			
	RR	L/R	KSH-038RCG			54660-4N000			
						54660-4N050			
GRACE H100	FRT	L/R	KSH-016FCO		444128	54300-43000			
						54300-43003			
						54300-43100			
						54300-43102			
						54300-43160			
						54300-43450			
						54300-43470			
						54300-43650			
						RR	L/R	KSH-016RCO	55300-43000
									55300-43100
	55300-43150								
	55300-43430								
	55300-43431								
	GALLOPER M100	FRT	L/R			KSH-050FCG	54310-M1060		
							54310-M1070		
54300-M1070									
HB217300									
HB217200									
RR		L/R		KSH-050RCG	54310-M1050				
					55310-M1400				
					HB227600				
					KSH-050RCO				
					55310-M1200				
GALLOPER M160	RR	L/R	KSH-051RCG	55310-M1600					
				55300-M1600					
				HB227400					
				54611-39400					
GRANDEUR XG	FRT	L/R	KSH-006FCG		341280 341245	54611-39401			
						54611-39402			
						54611-39403			
						54611-39404			
						54611-39410			
						54611-39502			
						54611-39504			
						54611-39700			
						RR	L/R	KSH-006RCG	55311-38500
									55311-39000
55311-39400									
55311-39501									
55311-38601									
GRANDEUR XG 02-MY	RR	L/R	KSH-006-1RCG	341281		55311-38610			
GRANDEUR TG	FRT	L/R	KSH-029FCG		341476	54611-3L020			
						54611-3L021			
						54611-3L030			
						54611-3L640			
						54611-3L770			
	RR		L/R			KSH-029RCG	55311-3L021		
							55311-3L030		
							55311-3L130		
							55311-3L630		
							55311-3L640		
						55311-3L770			

MODEL	FRT/RR	LH/RH/L/R	KIC	KYBI GAS	KYBI OIL	OE NO	
GRANDEUR HG	FRT	LH	KSH-030FLG			54651-3V010	
						54651-3V110	
		RH				KSH-030FRG	54651-3V210
							54661-3V010
							54661-3V110
	RR	L/R	KSH-030RCG			54661-3V210	
						55311-3V010	
						55311-3V050	
						55311-3V080	
						55311-3V500	
GRANDEUR HG EX	FRT	LH	KSH-031FLG			54651-3V410	
		RH	KSH-031FRG			54661-3V410	
GRANDEUR HG SX	FRT	LH	KSH-031FLG-16			54651-3V281	
		RH	KSH-031FRG-16			54651-3V500	
110 PA	FRT	LH	KSH-018FLG	332503		54650-0X000	
						54650-0X100	
		RH				KSH-018FRG	54650-0X200
							54650-1X100
							54660-0X000
	RR	L/R	KSH-018RCG			54660-0X100	
						54660-0X200	
						54660-1X100	
						55300-0X000	
						55300-0X100	
GRAND I10 BA	FRT	LH	KSH-035FLG			54650-B4000	
						54650-B4050	
		RH				KSH-035FRG	54650-B4100
							54650-B9000
							54660-B4000
	RR	L/R	KSH-035RCG			54660-B4050	
						54660-B4100	
						54660-B9000	
						55310-B4050	
						55310-B4060	
120 PB	FRT	LH	KSH-034FLG-GED			54650-1J000	
			KSH-034FLG-GE				
		RH	KSH-034FLG-ID			54650-1J200	
			KSH-034FRG-GED				
			KSH-034FRG-GE				
120 GB	FRT	LH	KSH-034RCG	3430039		54660-1J000	
						KSH-034FRG-ID	
		RH				KSH-034FRG-GE	54660-1J050
							54660-1J200
							55300-1J000
	RR	L/R	KSH-034RCG			55300-1J200	
						55310-1J000	
						55310-1J001	
						55310-1J101	
						546504-P500	
120 GB ACTIVE	FRT	LH	KSH-040FLG			54650-1J451	
		RH	KSH-040FRG			54660-4P500	
120 GB ACTIVE	RR	LH	KSH-036FLG			54660-1J451	
		RH	KSH-036FRG			54650-C7000	
		L/R	KSH-036RCG			54660-C7000	
130 FD	FRT	LH	KSH-019FLG	338025		55310-C7000	
						54651-2L000	
						54651-2L100	
						54651-2L101	
						54651-2L200	
		RH				KSH-019FRG	54651-2L201
							54651-2L600
							54661-2L000
							54661-2L100
							54661-2L101
						54661-2L200	
						54661-2L201	
						54661-2L600	

HYUNDAI

COMPATIBLE NO LIST

MODEL	FRT/RR	LH/RH/L/R	KIC	KYBI GAS	KYBI OIL	OE NO	
I30 FD	RR	L/R	KSH-019RCG	349084		55311-2L000	
						55311-2L100	
						55311-2L200	
						55311-2L600	
						55311-2R200	
						55300-A6000	
						55300-A6050	
						55300-A6400	
I30 FD CW	FRT	LH	KSH-019FLG-CW			54650-2R100	
						54651-2R400	
						54651-2R450	
						54651-2R600	
						54651-2R700	
						54651-1H600	
		RH	KSH-019FRG-CW				54660-2R100
							54661-2R400
							54661-2R450
							54661-2R600
							54661-2R700
							54661-1H600
I30 GD	FRT	LH	KSH-052FLG			54651-A5000	
		RH	KSH-052FRG			54661-A5000	
	RR	L/R	KSH-052RCG			55300-A5000	
LAVITA FC	FRT	LH	KSH-020FLG	333367		55300-A5060	
						54651-17100	
						54651-17200	
		RH	KSH-020FRG	333366			54651-17250
							54651-17500
							54651-17600
	RR	LH	KSH-020RLG	333505		54661-17100	
						54661-17200	
						54661-17250	
		RH	KSH-020RRG	333504			54661-17500
							54661-17600
							55351-17100
	MIGHTY1 EF4 86-MY	FRT	L/R	KSH-056FCO			55351-17200
		RR	L/R	KSH-056RCO			55351-17230
	MIGHTY 2	FRT	L/R	KSH-053FCO			55351-17500
		RR	L/R	KSH-053RCO			55351-17600
	PORTER AH	FRT	L/R	KSH-004FCO		444022	55361-17100
		RR	L/R	KSH-004RCO		444151	55361-17200
PORTER AU	FRT	L/R	KSH-005FCO			55361-17230	
						55361-17500	
	RR	L/R	KSH-005RCO	344102 (GAS)	444023	55361-17600	
						55300-4B000	
PORTER HR	FRT	L/R	KSH-025FCO		444128	55300-4B500	
		L/R	KSH-025FCG	554095		55300-4B700	
	RR	L/R	KSH-025RCO		444340	55310-4F000	
						55300-4F000	
						55300-4F300	
						55300-4F700	
		L/R	KSH-025RCG	554354		55300-4F350	
						55300-4F050	

HYUNDAI

COMPATIBLE NO LIST

MODEL	FRT/RR	LH/RH/L/R	KIC	KYBI GAS	KYBI OIL	OE NO	
SONATA Y2	FRT	L/R	KSH-040FCO		634063	54650-33102	
		L/R	KSH-040FCG	334058		54650-33200	
	RR	L/R	KSH-040RCO		441095	54650-33500	
		L/R	KSH-040RCG	341154		54650-33901	
SONATA Y3	FRT	L/R	KSH-041FCO		334141	55310-33100	
						55310-33900	
		L/R	KSH-041FCG				55310-33901
							54650-34020
	RR	L/R	KSH-041RCO		341192	54650-34200	
						54650-34220	
	L/R	KSH-041RCG				54650-34230	
						54650-34231	
	SONATA EF 98-MY	FRT	L/R	KSH-013FCO		341280	54650-34012
							54650-34130
54650-34310							
L/R			KSH-013FCG				55310-34020
							55310-34102
							55310-34220
RR		L/R	KSH-013RCO		341427	55310-34230	
						55310-34000	
L/R		KSH-013RCG				55310-34130	
						55310-34310	
SONATA EF 01-MY		FRT	L/R	KSH-023FCG	341477		54611-38001
							5431138651
							54611-38400
							54611-38500
	RR	L/R	KSH-013RCO			54611-38650	
						54611-38700	
						54611-38701	
						55311-38000	
SONATA NF	FRT	L/R	KSH-024FCG	341476		55311-38650	
						55311-38651	
						55311-38400	
						55311-38500	
SONATA EF 86-MY	FRT	L/R	KSH-023FCG	341478	341281	55311-38900	
						54611-38600	
	RR	L/R	KSH-023RCG			54611-38601	
						54611-38611	
	L/R	KSH-023RCG				54611-38630	
						55311-38600	
	L/R	KSH-023RCG				54611-38610	
						54611-38610	
	SONATA EF 01-MY	FRT	L/R	KSH-023FCG	341477		54611-38600
							54611-38601
54611-38610							
54611-38611							
54611-38630							
55311-38600							
RR		L/R	KSH-023RCG			55311-38601	
						55311-38610	
L/R		KSH-023RCG				54611-3K010	
						54611-3K020	
L/R		KSH-023RCG				54611-3K030	
						54611-3K040	
L/R		KSH-023RCG				54611-3K050	
						54611-3K060	
L/R	KSH-023RCG				54611-3K130		
					54611-3K140		
L/R	KSH-023RCG				54611-3K630		
					54611-3K770		
SONATA EF 01-MY	FRT	L/R	KSH-024FCG	341476		55311-3K010	
						55311-3K020	
						55311-3K030	
						55311-3K040	
	RR	L/R	KSH-024RCG	349060			55311-3K050
							55311-3K060
							55311-3K130
							55311-3K630
L/R	KSH-024RCG					55311-3K770	
						55311-3K780	

MODEL	FRT/RR	LH/RH/L/R	KIC	KYBI GAS	KYBI OIL	OE NO		
SONATA YF	FRT	LH	KSH-046FLG			54651-3S010		
						54651-3S060		
						54651-3S061		
		54651-3S220						
		54651-3S020						
		54661-3S010						
	RH	KSH-046FRG				54661-3S060		
						54661-3S061		
						54661-3S220		
		54661-3S020						
		RR	L/R	KSH-046RCG				55311-3S020
								55311-3S060
55311-3S010								
55311-2T230								
54651-3Q623								
54651-3Q610								
SONATA YF-US	FRT	LH	KSH-054FLG			54661-3Q623		
		RH	KSH-054FRG			54661-3Q610		
SONATA LF 14-MY	FRT	LH	KSH-047FLG			54650-C1000		
						54650-C1050		
						54650C1600		
		RH	KSH-047FRG				54660-C1000	
							54660-C1050	
							54660-C1600	
	RR	L/R	KSH-047RCG				55311-C1100	
							55311-C1110	
							55311-C1200	
							54310-4A000	
							54310-4A500	
							54300-4A600	
STAREX A1	FRT	L/R	KSH-042FCO		344285	54310-4A100		
						54310-4A110		
						54310-4A600		
		L/R	KSH-042FCG				54610-4A700	
							55300-4A000	
							55310-4A300	
	RR	L/R	KSH-L042RCO		344286	55310-4A500		
						55310-4A700		
						55310-4A000		
		L/R	KSH-L042RCG			344287	55310-4A100	
							55310-4A800	
							55310-4A850	
STAREX H1	RR	L/R	KSH-S042RCO			55310-4A800		
		L/R	KSH-S042RCG			55310-4A850		
STAREX H1 4WD	FRT	L/R	KSH-042FCG4-WD			55310-4A800		
	RR	L/R	KSH-042RCO-4WD			55310-4A850		
GRAND STAREX TQ	FRT	LH	KSH-017FLG	339399		54650-4H000		
						54650-4H050		
						54650-4H100		
		RH	KSH-017FRG	339398			54650-4H150	
							54650-4H600	
							54650-4H650	
		RR	L/R	KSH-S017RCG	349166			54660-4H000
								54660-4H050
								54660-4H100
	L/R		KSH-L017RCG-V				54660-4H150	
							54660-4H600	
							54660-4H650	
	GRAND STAREX TQ VAN	RR	L/R	KSH-L017RCG-V			55300-4H000	
							55300-4H050	
							55300-4H100	
							55300-4H150	
							55300-4H500	
							55300-4H550	
55300-4H600								
55300-4H650								
GRAND STAREX TQ 17-MY							FRT	LH
	54650-4H155							
	54650-4H655							
	RH	KSH-060FRG				54660-4H055		
						54660-4H155		
						54660-4H655		

MODEL	FRT/RR	LH/RH/L/R	KIC	KYBI GAS	KYBI OIL	OE NO	
SANTAFE SM	FRT	LH	KSH-028FLG	339749		54650-26000	
						54650-26100	
						54650-26200	
		RH	KSH-028FRG	339748			54650-26300
							54650-26500
							54650-26600
	RR	L/R	KSH-028RCG				54660-26100
							54660-26000
							54660-26200
							54660-26300
							54660-26500
							54660-26600
SANTAFE CM 05-MY	FRT	LH	KSH-027FLG	339751		55305-26000	
						55305-26200	
						55305-26500	
		RH	KSH-027FRG	339750			55305-26800
							55305-26900
							54650-2B000
	RR	L/R	KSH-027RCG				54650-2B001
							54650-2B100
							54650-2B200
							54650-2B201
							54660-2B000
							54660-2B001
SANTAFE CM 09-MY	FRT	LH	KSH-032FLG			54650-2B200	
						54650-2B201	
						55310-2B000	
		RH	KSH-032FRG				55310-2B001
							55310-2B201
							55310-2B211
	RR	L/R	KSH-027RCG				55310-2B500
							55310-2B510
							55310-2B520
							54650-2B000
							54650-2B001
							54650-2B100
SANTAFE DM	FRT	LH	KSH-033FLG	335625		54650-2B200	
						54650-2B201	
						54650-2B640	
		RH	KSH-033FRG	335624			54650-2B500
							54650-2B510
							54650-2B540
	RR	L/R	KSH-033RCG				54650-2B640
							54660-2B500
							54660-2B510
							54660-2B540
							54660-2B640
							54651-2W000
SANTAFE DM	FRT	LH	KSH-033FLG	335625		54651-2W100	
						54651-2W200	
						54651-2W400	
		RH	KSH-033FRG	335624			54651-2W450
							54661-2W000
							54661-2W100
SANTAFE DM	FRT	LH	KSH-033FLG	335625		54661-2W200	
						54661-2W400	
						54661-2W450	
		RH	KSH-033FRG	335624			54661-2W000
							54661-2W100
							54661-2W200

MODEL	FRT/RR	LH/RH/L/R	KIC	KYBI GAS	KYBI OIL	OE NO	
SANTAFE DM	RR	L/R	KSH-033RCG			55310-2W010	
						55310-2W100	
						55310-2W110	
						55310-2W500	
						55310-2W550	
SANTAFE DM-4WD	RR	L/R	KSH-033RCG-4WD			55310-2W300	
						55310-2W320	
						55310-2W330	
						55310-2W800	
						55310-2W850	
						54651-2E000	
						54651-2E001	
TUCSON JM	FRT	LH	KSH-044FLG	339743		54651-2E200	
						54651-2E201	
						54651-2E500	
			KSH-044FRG	339742		54661-2E000	
						54661-2E001	
						54661-2E201	
	RR	LH	KSH-044RLG	339747		54661-2E500	
						55351-2E000	
						55351-2E001	
		RH	KSH-044RRG	339746		55351-2E002	
						55351-2E200	
						55351-2E202	
	TUCSON LM	FRT	LH	KSH-045FLG	339403		55351-2E501
							55361-2E000
							55361-2E001
RH			KSH-045FRG	339402		55361-2E002	
						55361-2E200	
						55361-2E202	
RR		L/R	KSH-045RCG	349243		55361-2E501	
						55361-2E000	
						55361-2E001	
			KSH-045FRG	339402		55361-2E002	
						55361-2E200	
						55361-2E202	
			KSH-045RCG-4WD	349187		55361-2E501	
						55361-2E000	
						55361-2E001	
TUCSON TL	FRT	LH	KSH-049FLG			54651-D3000	
		RH	KSH-049FRG			54661-D3000	
TUCSON TLE	FRT	L/R	KSH-049RCG			55311-2S000	
						55311-2S010	
						55311-2S011	
TUCSON TLE	FRT	L/R	KSH-049RCG			55311-2S050	
						55311-2S650	
						55311-2S850	
TUCSON TLE	FRT	L/R	KSH-049RCG			55311-2S400	
						55311-2S450	
						55311-2S411	
TUCSON TLE	FRT	L/R	KSH-049RCG			55311-2S950	
						55311-2S410	
						55311-2S410	
TUCSON TLE	FRT	L/R	KSH-049RCG			54651-D3000	
						54661-D3000	
						55311-D3000	
TUCSON TLE	FRT	L/R	KSH-049RCG			55311-D3220	
						54650-D7000	
						54660-D7000	

MODEL	FRT/RR	LH/RH/L/R	KIC	KYBI GAS	KYBI OIL	OE NO
TRAJET FO	FRT	LH	KSH-043FLG	334238		54650-3A200
						54650-3A501
		RH	KSH-043FRG	334237		54650-3A502
						54650-3A505
						54660-3A200
	RR	L/R	KSH-043RCG	344297		54660-3A501
						54660-3A502
						54660-3A505
						55300-3A000
						55300-3A010
TIBURON RD	FRT	LH	KSH-058FLG	333206		55300-3A501
						55300-3A505
		RH	KSH-058FRG	333205		55300-3A510
						54650-27130
						54651-27300
	RR	LH	KSH-058RLG	333208		54651-29650
						54660-27130
		RH	KSH-058RRG	333207		54661-27300
						54661-29650
						55351-27130
TUSCANI GK	RR	LH	KSH-059RLG	333782		55351-27300
		RH	KSH-059RRG	333781		55361-27130
VERNA LC	FRT	LH	KSH-021FLO			55351-2C000
						55360-2C000
						55361-2C000
						54650-25000
						54650-25050
		RH	KSH-021FRG	333304		54650-25100
						54650-25150
						54650-25500
						54650-25550
						54650-25600
	RR	LH	KSH-021FLG	333305		54650-25650
						54650-25700
						54650-25750
						54650-25800
						54650-25850
		RH	KSH-021FRG	333304		54660-25000
						54660-25050
						54660-25100
						54660-25150
						54660-25500
	RR	LH	KSH-021RLO	332109		54660-25550
						54660-25600
						54660-25650
						54660-25700
						54660-25750
RR	LH	KSH-021RLG	332109		54660-25800	
					54660-25850	
					55350-25000	
					55350-25050	
					55350-25100	
VERNA LC	FRT	LH	KSH-021FRO			55350-25101
						55350-25150
						55350-25151
						55350-25500
						55350-25501
	RR	LH	KSH-021RLG	332109		55350-25600
						55350-25650
						55350-25700
						55350-25750
						55350-25800
VERNA LC	FRT	LH	KSH-021RLG	332109		55350-25850
						55350-25850
						55350-25850
						55350-25850
						55351-25700

HYUNDAI

COMPATIBLE NO LIST

MODEL	FRT/RR	LH/RH/L/R	KIC	KYBI GAS	KYBI OIL	OE NO
VERNA LC	RR	RH	KSH-021RRO		332108	55360-25000
						55360-25050
						55360-25100
						55360-25101
						55360-25150
						55360-25500
			KSH-021RRG		332108	55360-25151
						55360-25501
						55360-25600
						55360-25650
						55360-25700
						55360-25750
VERNA MC	FRT	LH	KSH-022FLG	333517		54650-1E000
						54650-1E100
						54650-1E200
						54650-1E300
						54660-1E000
						54660-1E100
	RH	KSH-022FRG	333516		54660-1E200	
					54660-1E300	
					55310-1E000	
					55310-1E100	
					55310-1E150	
					55310-1E200	
RR	L/R	KSH-022RCG	348002		55310-1E300	
					54651-2V050	
					54651-2V150	
					54651-2V351	
					54651-2V360	
					54651-2V930	
VELOSTER FS	FRT	LH	KSH-039FLG			54651-2V900
						54651-2V350
						54661-2V050
						54661-2V150
						54661-2V351
						54661-2V360
		RH	KSH-039FRG			54661-2V930
						54661-2V900
						54661-2V350
						54661-2V050
						54661-2V150
						54661-2V351

KIA

COMPATIBLE NO LIST

MODEL	FRT/RR	LH/RH/L/R	KIC	KYBI GAS	KYBI OIL	OE NO
BESTA F70Y	FRT	L/R	KSK-001FCO		444162 344302	0K71E-34-700 0K710-34-700
	RR	L/R	KSK-001RCO		443302 344063	0K71E-28-700 0K721-28-700
BONGO FORNTIER BA2	FRT	L/R	KSK-001FCO-BF		444162 344302	0K06A-34-700A M71E-34-700
	RR	L/R	KSK-001RCO-BF		444025 344063	0K06A-28-700B 0K06A-28-700A 0K60A-28-700C
BONGO FORNTIER BA2 1.3T	RR	L/R	KSK-001RCO-BF.1.3			0K42A-28-710
BONGO3 PU	FRT	L/R	KSK-004FCG	3440046		54300-4E000 54300-4E100 54300-4E101
	RR	L/R	KSK-004RCG	3440031 349154		55300-4E000 55300-4E100 55300-4E400 55310-4E000
BONGO3 PU K25	FRT	L/R	KSK-001FCO-K25			344302 54300-4E200
BONGO3 PU 1.4T	FRT	L/R	KSK-002FCG			54300-4E600 54300-4E700
	RR	L/R	KSK-002RCG			55300-4E600 55300-4E700 55310-4E600 55310-4E700
CEED ED	FRT	LH	KSK-006FLG	339258 338025		54651-1H100 54651-1H000
		RH	KSK-006FRG	339257 338024		54661-1H100 54661-1H000
CEED ED SW	FRT	L/R	KSK-006RCG	349084		55311-1H100 55310-1H102
		LH	KSK-006FLG-SW			54651-1H600 54651-1H700
CEED ED SW	FRT	RH	KSK-006FRG-SW			54661-1H600 54661-1H700
		LH	KSK-005FLG	333491		54651-2F000 54651-2F100 54651-2F200 54651-2F300 54651-2F400 54651-2F500
CERATO LD	FRT	RH	KSK-005FRG	333490		54661-2F000 54661-2F100 54661-2F200 54661-2F300 54661-2F400 54661-2F500
		LH	KSK-005RLG	333493		55351-2F000 55351-2F100 55351-2F200 55351-2F300 55351-2F301 55351-2F400 55351-2F401 55351-2F500
CERATO LD	RR	LH	KSK-005RLG	333493		55361-2F000 55361-2F100 55361-2F200 55361-2F300 55361-2F301 55361-2F400 55361-2F401 55361-2F500
		RH	KSK-005RRG	333492		55361-2F000 55361-2F100 55361-2F200 55361-2F300 55361-2F301 55361-2F400 55361-2F401 55361-2F500

MODEL	FRT/RR	LH/RH/L/R	KIC	KYBI GAS	KYBI OIL	OE NO
CARENS RS 99-MY	FRT	LH	KSK-045FLG			0K2FB-34-900C
		RH	KSK-045FRG			0K2FB-34-700C
		LH	KSK-046FLG			0K2JB-34-900A
		RH	KSK-046FRG			0K2JB-34-700A
	RR	LH	KSK-045RLG			0K2FB-28-900B 0K2JB-28-900B
		RH	KSK-045RRG			0K2FB-28-700B 0K2JB-28-700B
CARENS UN	FRT	LH	KSK-013FLG	334509		54651-1D000
						54651-1D001
						54651-1D100
						54651-1D101
						54651-1D200
						54651-1D201
		RH	KSK-013FRG	334508		54661-1D000
						54661-1D001
						54661-1D100
						54661-1D101
	RR	L/R	KSK-013RCG	344501		54661-1D200
						54661-1D201
						55311-1D000
						55311-1D010
						55311-1D020
						55311-1D200
						55311-1D400
						55311-1D400
FRT	LH	KSK-030FLG	335043		0K552-34-900B	
					0K552-34-900E	
					0K553-34-900C	
					0K55B-34-900	
					0K552-34-700B	
	RH	KSK-030FRG	335042		0K552-34-700E	
					0K553-34-700A	
					0K553-34-700C	
					0K53A-28-700C	
					0K552-28-700	
RR	L/R	KSK-030RCG	344296		0K552-28-700A	
					0K552-28-700C	
					0K552-28-700E	
					0K55A-28-700	
					0K552-34-900B	
					0K552-34-900E	
					0K553-34-900C	
					0K55B-34-900	
					0K552-34-700B	
					0K552-34-700E	
FRT	LH	KSK-031FLG	339310		0K553-34-700A	
					0K553-34-700C	
					0K55B-34-900	
					0K552-34-700B	
					0K552-34-700E	
	RH	KSK-031FRG	339309		0K553-34-700A	
					0K553-34-700C	
					55310-4D000	
					55310-4D100	
					55310-4D600	
RR	L/R	KSK-031RCG	349094		54650-1M000	
					54650-1M300	
					54650-1M310	
					54650-1M510	
					54660-1M000	
					54660-1M300	
FRT	LH	KSK-008FLG	338027		54660-1M310	
					54660-1M510	
					54660-1M000	
					54660-1M300	
					54660-1M310	
	RH	KSK-008FRG	338026		54660-1M510	
					55300-1M000	
					55300-1M300	
					55300-1M300	
					55300-1M350	
RR	L/R	KSK-008RCG	554385		55300-1M300	
					55300-1M300	
					55300-1M350	

MODEL	FRT/RR	LH/RH/L/R	KIC	KYBI GAS	KYBI OIL	OE NO
LOTZE MG	FRT	LH	KSK-010FLG			54651-2G000
						54651-2G200
						54651-2G300
						54651-2G310
						54651-2G400
		RH	KSK-010FRG			54651-2G410
						54651-2G600
						54651-2G610
						54651-2G630
						54651-2G700
	RR	L/R	KSK-010RCG			54661-2G000
						54661-2G200
						54661-2G300
						54661-2G310
						54661-2G400
						54661-2G410
						54661-2G600
						54661-2G610
						54661-2G630
						54661-2G700
FRT	LH	KSK-011FLO			55311-2G100	
					55311-2G400	
					55311-2G410	
					55311-2G600	
					55311-2G630	
	RH	KSK-011FRO			54650-07000	
					54650-07100	
					54650-07200	
					54660-07000	
					54660-07100	
RR	L/R	KSK-011RCO			54660-07200	
					55310-07000	
					55310-07001	
					55310-07100	
					55310-07200	
					54650-1Y000	
					54650-1Y001	
					54650-1Y010	
					54650-1Y100	
					54650-1Y200	
FRT	LH	KSK-012FLG		3320021	54650-1Y201	
					54660-1Y000	
					54660-1Y001	
					54660-1Y010	
					54660-1Y100	
	RH	KSK-012FRG			54660-1Y200	
					54660-1Y201	
					55300-1Y000	
					55300-1Y200	
					55310-1Y000	
RR	L/R	KSK-012RCG		348053	55310-1Y100	
					55310-1Y200	
					54650-G6000	
					54650-G6100	
					54660-G6000	
					54660-G6100	
					55310-G6000	
					54651-2J001	
					54651-2J100	
					54651-2J300	
FRT	LH	KSK-044FLG			54651-2J320	
					55310-2J000	
					55310-2J100	
					55310-2J300	
					55310-2J401	
	RH	KSK-044FRG			55320-2J000	
					55320-2J100	
					55320-2J100	
					55320-2J300	
					55320-2J300	
RR	L/R	KSK-044RCG			55320-2J000	
					55320-2J100	
FRT	LH	KSK-036FCG			55320-2J100	
					55320-2J300	
					55320-2J300	
					55320-2J300	
					55320-2J300	
	RH	KSK-036RRG			55320-2J300	
					55320-2J300	
					55320-2J300	
					55320-2J300	
					55320-2J300	
MORNING JA	FRT	LH	KSK-044FLG			55320-2J300
						55320-2J300
						55320-2J300
						55320-2J300
						55320-2J300
	RR	L/R	KSK-044RCG			55320-2J300
						55320-2J300
						55320-2J300
						55320-2J300
						55320-2J300
MORNING TA	FRT	RH	KSK-012FRG		3320020	55320-2J300
						55320-2J300
						55320-2J300
						55320-2J300
						55320-2J300
	RR	L/R	KSK-012RCG			55320-2J300
						55320-2J300
						55320-2J300
						55320-2J300
						55320-2J300
MORNING SA	FRT	LH	KSK-011FLO			55320-2J300
						55320-2J300
	RR	L/R	KSK-011RCO			55320-2J300
						55320-2J300

MODEL	FRT/RR	LH/RH/L/R	KIC	KYBI GAS	KYBI OIL	OE NO
K3 YD	FRT	LH	KSK-032FLG	3440062		54651-A7000
						54651-A7100
						54651-A7210
						54651-A7300
						54651-A7400
						54651-A7AB0
	RR	L/R	KSK-032RCG	349184		54661-A7000
						54661-A7100
						54661-A7210
						54661-A7300
						54661-A7400
						54661-A7AB0
	FRT	RH	KSK-032FRG	3440061		55300-A7000
						55300-A7100
						55300-A7200
RR	L/R	KSK-032RCG	349184		55300-A7400	
					55300-A7000	
					55300-A7100	
K5 TF	FRT	LH	KSK-009FLG			54651-2T011
						54651-2T021
						54651-2T120
						54651-2T230
						54661-2T011
						54661-2T021
	RR	L/R	KSK-009RCG			54661-2T120
						54661-2T230
						55311-2T010
						55311-2T020
						55311-2T230
						54651-2T010
FRT	RH	KSK-033FLG			54651-2T020	
					54651-4R010	
					54661-2T010	
					54661-2T020	
					54661-4R010	
					54661-2T012	
FRT	LH	KSK-009FLG-16			54651-2T232	
					54651-2T250	
					54651-2T022	
					54661-2T022	
					54661-2T232	
					54661-2T250	
FRT	RH	KSK-009FRG-16			54661-2T012	
					54661-2T022	
					54661-2T232	
					54661-2T250	
					54661-2T012	
					54651-2T124	
K5 TF EX	FRT	LH	KSK-016FLG			54651-2T224
						54651-2T410
						54651-2T420
						54651-2T430
						54651-2T440
						54651-2T450
						54651-2T460
						54651-2T470
						54651-4R025
	RR	L/R	KSK-016FRG			54651-3V281
						54661-2T124
						54661-2T224
						54661-2T410
						54661-2T420
						54661-2T430
						54661-2T440
						54661-2T450
						54661-2T460
FRT	RH	KSK-016FRG			54661-2T470	
					54661-4R025	
					54661-3V281	

MODEL	FRT/RR	LH/RH/L/R	KIC	KYBI GAS	KYBI OIL	OE NO
K5 JF	FRT	LH	KSK-042FLG			54650-D4000
						54650-D4500
						54650-D4580
	RR	L/R	KSK-042RCG			54660-D4000
						54660-D4500
						54660-D4580
FRT	RH	KSK-042FRG			55311-D4000	
					55311-D4110	
					55311-D4200	
K7 VG	FRT	LH	KSK-043FLG			54651-3R021
	RR	L/R	KSK-007RCG			54661-3R021
K7 VG SX	FRT	LH	KSK-007FLG			55311-3R020
		RH	KSK-007FRG			54651-3R130
K7 VG EX	FRT	LH	KSK-037FLG			54651-3R330
		RH	KSK-037FRG			54661-3R130
OPTIMA MS	FRT	LH	KSK-037RCG			54661-3R330
		RR	L/R	KSK-037RCG		
PREGIO NB9	FRT	L/R	KSK-034FCG	341477		54651-3R900
						54661-3R800
						54661-3R900
	RR	L/R	KSK-034RCG			55311-3R800
						55311-38600
						55311-38610
K5 TF TGD1	FRT	LH	KSK-033FLG			54311-38600
						54611-38600
						54611-38610
	RR	L/R	KSK-034RCO			54611-38630
						54311-38600YO
						55311-38600
PREGIO NB9 VAN	FRT	L/R	KSK-018FCG	341247		55311-38610
						55311-38600YO
						55311-38610
						55311-38610
						55311-38600YO
						55311-38600
	RR	L/R	KSK-S018RCG			0K72A-34-700
						0K72A-34-710
						0K72A-34-710A
						0K72A-34-710B
						0K72A-34-910C
						0K72A-34-910D
FRT	RH	KSK-018FRG			0K72A-34-920	
					0K79A-34-710	
					0K72A-28-700	
					0K79A-28-700	
					0K72A-28-700A	
					0K72A-28-700C	
RR	L/R	KSK-L018RCG	344292		0K72A-28-701D	
					0K72K-28-10XE	
					0K72K-28-10YE	
					0K72K-28-700	
					0K72K-28-700B	
					0K72K-28-700A	
PRIDE NB3	FRT	LH	KSK-019FLO			KK137-34-900
						KK137-34-900A
						KKY01-34-900
						KKY01-34-900B
						MD001-34-900A
						KK137-34-700
	RR	L/R	KSK-019RCO			KK137-34-700A
						KKY01-34-700
						KKY01-34-700B
						MD001-34-700A
						KK135-28-700
						KK135-28-700A
K5 TF EX	FRT	RH	KSK-019FRO			KK135-28-700B
						KK153-28-700
						KKY01-28-700
						KKY01-28-700D
						KKY01-28-700Z
						MD001-28-700H
	RR	L/R	KSK-019RCO			MD001-28-700K
						MD001-28-700K
						MD001-28-700K
						MD001-28-700K
						MD001-28-700K
						MD001-28-700K

MODEL	FRT/RR	LH/RH/L/R	KIC	KYBI GAS	KYBI OIL	OE NO	
PRIDE UB	FRT	LH	KSK-020FLG	338107		54650-1W030	
						54650-1W051	
						54650-1W100	
		54650-1W200					
		54650-1W400					
		54660-1W030					
	RH	KSK-020FRG	338106		54660-1W051		
					54660-1W100		
					54660-1W200		
					54660-1W400		
					55300-1W000		
					55300-1W100		
RR	L/R	KSK-020RCG	554384		55300-1W200		
					55300-1W400		
					55300-1W000		
					55300-1W100		
					55300-1W200		
					55300-1W400		
RIO BC	FRT	LH	KSK-021FLO			0K30A-34-900H	
		RH	KSK-021FRO			0K30A-34-700H	
	RR	L/R	KSK-021RCO		343353	0K30A-28-700	
						0K30A-28-700K	
						0K33C-28-700	
						0K33C-28-700A	
KSK-021RCG			0K30A-28-700H				
RIO BC 00-MY	FRT	LH	KSK-022FLO	333503		0K30A-34-900J	
						0K30A-34-900K	
						0K32B-34-900	
		0K33C-34-900F					
		0K30A-34-700J					
		0K30A-34-700K					
	RH	KSK-022FRO	333502		0K32B-34-700		
					0K33C-34-700F		
					54650-FD000		
					54650-FD050		
					54650-FD100		
					54650-FD101		
RIO BC SF	FRT	LH	KSK-023FLG	333513		54660-FD000	
						54660-FD050	
						54660-FD100	
		54660-FD101					
		RH	KSK-023FRG	333512		55310-FD000	
						55310-FD051	
	55310-FD150						
	55310-FD200						
	0K201-34-900E						
	0K203-34-900						
	SEPHIA S1	FRT	LH	KSK-024FLO		633169 333110	0K203-34-900B
							0K203-34-900E
0K203-34-900F							
0K203-34-900G							
0K216-34-900							
0K216-34-900A							
RH		KSK-024FRO		633168 333109	0K201-34-700E		
					0K203-34-700		
					0K203-34-700E		
					0K203-34-700F		
					0K203-34-700G		
					0K216-34-700		
SPECTRA SD	FRT	LH	KSK-024RLO		333372	0K216-34-700A	
						0K201-28-900	
						0K216-28-900	
		0K216-28-900A					
		0K216-28-900B					
		0K216-28-900C					
	RR	L/R	KSK-024RRO		333371	0K201-28-700	
						0K201-28-700B	
						0K201-28-700C	
						0K201-28-700D	
						0K201-28-700E	
						0K201-28-700F	
0K216-28-700							
0K216-28-700B							
0K216-28-700C							

MODEL	FRT/RR	LH/RH/L/R	KIC	KYBI GAS	KYBI OIL	OE NO
SEPHIA S2	FRT	LH	KSK-025FLG	333263		0K2A1-34-900
						0K2A3-34-900
						0K2A1-34-900C
						0K2A1-34-900D
						0K2A1-34-900E
						0K2A1-34-900F
		RH	KSK-025FRG	333262		0K2A1-34-900G
						0K2A1-34-900H
						0K2A3-34-900D
						0K2A3-34-900E
						0K2A3-34-900F
						0K2A3-34-900G
	RR	LH	KSK-025RLG	333265		0K2A1-34-700
						0K2A3-34-700
						0K2A1-34-700D
						0K2A1-34-700E
						0K2A1-34-700F
						0K2A1-34-700G
		RH	KSK-025RRG	333264		0K2A1-34-700H
						0K2A3-34-700D
						0K2A3-34-700E
						0K2A3-34-700F
						0K2A3-34-700G
						0K2A3-34-700H
SPECTRA SD	FRT	LH	KSK-026FLG	333317		0K2A1-28-900
						0K2A3-28-900
						0K2A1-28-900B
		RH	KSK-026FRG	333316		0K2A1-28-900C
						0K2A1-28-900D
						0K2A3-28-900B
	RR	LH	KSK-026RLG	333303		0K2A3-28-900C
						0K2A3-28-900D
						0K2A3-28-900E
		RH	KSK-026RRG	333302		0K2A1-28-700
						0K2A3-28-700
						0K2A1-28-700B
0K2A1-28-700C						
0K2A3-28-700C						
0K2A3-28-700D						
0K2A3-28-700E						
0K2NA-34-900A						
0K2NB-34-900A						
0K2NE-34-900						
0K2NF-34-900						
0K2NA-34-700A						
0K2NB-34-700A						
0K2NE-34-700						
0K2NF-34-700A						
0K2N1-28-900A						
0K2N3-28-900A						
0K2NE-28-900A						
0K2NF-28-900A						
0K2N1-28-700A						
0K2N3-28-700A						
0K2NE-28-700A						
0K2NF-28-700A						

MODEL	FRT/RR	LH/RH/L/R	KIC	KYBI GAS	KYBI OIL	OE NO					
SORENTO BL 02-MY	FRT	LH	KSK-015FLG	341365		54630-3E000					
						54630-3E005					
						54630-3E010					
						54630-3E020					
						54630-3E021					
						54630-3E022					
						54630-3E023					
						54630-3E030					
						54630-3E031					
						54630-3E032					
						54630-3E100					
						54630-3E200					
						54630-3E300					
						RR	L/R	KSK-015RCG	344451		55300-3E000
											55300-3E010
	55300-3E020										
	55300-3E021										
	55300-3E022										
	55300-3E030										
	55300-3E031										
	55300-3E032										
	55300-3E100										
	55300-3E200										
	55300-3E300										
	55310-3E001										
	55310-3E500										
	55310-3E600										
	55310-3E600										
	SORENTO BL 06-MY	RR	L/R	KSK-017RCG	349115		54650-1U300				
							54650-2P000				
54650-2P100											
54650-2P500											
54660-1U300											
54660-2P000											
54660-2P100											
54660-2P500											
55310-2P000											
55310-2P100											
55310-2P200											
55310-2P300											
55310-2P600											
55310-2P500											
55310-2P500											
SORNETO XM	FRT	LH	KSK-028FLG	3340122		54651-2P400					
						54651-2P900					
						54661-2P400					
	RR	L/R	KSK-028RCG	341716 3440028		54661-2P900					
						55310-2P400					
						55310-2P430					
SORNETO XM 4WD	RR	L/R	KSK-035RCG	3440072		54651-2P400					
						54651-2P900					
SORENTO XM 12-MY	FRT	LH	KSK-028FLG-N			54661-2P400					
		RH	KSK-028FRG-N			54661-2P900					
	RR	L/R	KSK-028RCG-N			55310-2P400					
						55310-2P430					

MODEL	FRT/RR	LH/RH/L/R	KIC	KYBI GAS	KYBI OIL	OE NO
SORENTO UM	FRT	LH	KSK-040FLG			54650-C5000
						54651-C5100
						54651-C5000
	RR	L/R	KSK-040RCG			54651-C5150
						54660-C5000
						54661-C5100
SOUL AM	FRT	LH	KSK-029FLG			54661-C5000
						54661-C5000
						54661-C5150
						54661-C5150
						55310-C5000
						55310-C5050
	RR	L/R	KSK-029RCG	349132		54650-2K000
						54650-2K100
						54650-2K200
						54650-2K300
						54650-2K800
						54650-2K820
						54650-2K930
						54650-2K960
						54660-2K000
SOUL PS	FRT	LH	KSK-038FLG			54660-2K100
						54660-2K200
						54660-2K300
						54660-2K800
						54660-2K820
						54660-2K930
	RR	L/R	KSK-038RCG	349132		54660-2K960
						55300-2K000
						55300-2K100
						55300-2K200
						55300-2K300
						55300-2K500
						55300-2K800
						55300-2K960
						55300-2K960
SPORTAGE KM	FRT	LH	KSK-003FLG	339743		54650-B2000
		RH	KSK-003FRG	339742		54650-B2030
	RR	L/R	KSK-038RCG			54650-B2040
						54650-B2100
						54660-B2000
						54660-B2030
SPORTAGE SL	FRT	LH	KSK-027FLG	339403		54660-B2040
						54660-B2100
						55300-B2030
	RR	L/R	KSK-027RCG			55300-B2040
						55300-B2130
						55310-B2000
SPORTAGE SL 4WD	FRT	RH	KSK-038FRG	339747		55310-B2030
						55310-B2040
						55310-B2100
	RR	L/R	KSK-027FRG	339402		54651-1F000
						54661-1F000
						55351-1F000
SPORTAGE KM	RR	L/R	KSK-003RLG	339747		55351-1F500
						55361-1F500
						55361-1F500
SPORTAGE SL	FRT	LH	KSK-027FLG	339403		54651-3W050
						54651-3W550
						54651-3W600
	RR	L/R	KSK-027RCG			54661-3W050
						54661-3W550
						54661-3W600
SPORTAGE SL 4WD	RR	L/R	KSK-027RCG-4WD	349187		55311-3W050
						55311-3W010
						55311-3W870
SPORTAGE KM	RR	L/R	KSK-003RRG	339746		55311-3W450
						55311-3W410
						55311-3W410

MODEL	FRT/RR	LH/RH/L/R	KIC	KYBI GAS	KYBI OIL	OE NO
SPORTAGE QL	FRT	LH	KSK-047FLG			54650-D9200
						54650-D9000
						54650-D9050
		RH	KSK-047FRG			54660-D9200
						54660-D9000
	RR	L/R	KSK-047RCG			55311-D9200
						55311-D9210
						55311-D9100
						55311-D9110
						AA100-34-900B
TOWNER S80	FRT	LH	KSK-039FLG			AA100-34-700B
		RH	KSK-039FRG			AA100-34-700B
	RR	L/R	KSK-039RCO			AA100-28-700
TOWNER S80 VAN	RR	L/R	KSK-039RCO-VAN			AA110-28-700AS
VENGA VN	FRT	LH	KSK-041FLG			54650-1P100
		RH	KSK-041FRG			54650-1P100

MODEL	FRT/RR	LH/RH/L/R	KIC	KYBI GAS	KYBI OIL	OE NO	
AVEO T300	FRT	LH	KSD-025FLG			95917154	
		RH	KSD-025FRG			95917155	
	RR	L/R	KSD-025RCG			52016646	
						95077490	
						95479781	
						95913279	
CIELO	FRT	L/R	KSD-001FCO		665036 365025	90236448	
						90236449	
						90272631	
						90373163	
						95079823	
						96179847	
						96187438	
						96187439	
						96208556	
						96212996	
	96226992						
	RR	L/R	KSD-001RCO		443134 343047	90236451	
						90236452	
						90272953	
						90373164	
						90373165	
						96129896	
						96169523	
						96179845	
						96187422	
96187423							
COBALT 04-MY	FRT	LH	KUD-001FLG	3330042		52024164	
		RH	KUD-001FRG	3330041		95917162	
	RR	L/R	KUD-001RCG			52024163	
						9917163	
						52016646	
						94708461	
COLORADO RG 11-MY	FRT	L/R	KSD-024FCG	340107		94774240	
	RR	L/R	KSD-024RCG	349221		94583379	
DAMAS DA51	FRT	LH	KSD-002FLO		333066	41602A85201	
		RH	KSD-002FRO		333065	94583376	
	RR	L/R	KSD-002RCO			41601A85201	
						94583399	
						94583400	
						41700A75D10	
ESPERO	FRT	L/R	KSD-003FCO		665036	90236448	
						90236449	
			KSD-003FCG			365025	90373163
							96164590
							96179847
	RR	L/R	KSD-003RCO		443134	96187438	
						96208555	
						96214332	
						96179848	
						96129816	
KSD-003RCG	343047				96160135		
					96169524		
					96179845		
					96213698		
						96162657	
						96185195	

DAEWOO/GM/CHEVROLET

COMPATIBLE NO LIST

MODEL	FRT/RR	LH/RH/L/R	KIC	KYBI GAS	KYBI OIL	OE NO
KALOS T200	FRT	LH	KSD-004FLO		333418 338012	96408661
						96408663
						96534981
						96534983
						96586885
						96586887
		KSD-004FLG	96410165			
			96410167			
			96431038			
			96431042			
			96449541			
			96449543			
	RH	KSD-004FRO		333417 338011	96980824	
					96408662	
					96408664	
					96534982	
					96534984	
					96586886	
		KSD-004FRG	96586888			
			96410166			
			96410168			
			96431039			
			96431043			
			96449542			
RR	L/R	KSD-004RCO		443399	96449544	
					96980825	
					96408735	
					96494605	
					96535158	
					96410116	
KSD-004RCG	343423	96430992				
		96449571				
		96226992				
		96445024				
		96445038				
		96445039				
LANOS T100	FRT	L/R	KSD-007FCO		665036 365025	96226990
						96246626
						96445040
	RR	L/R	KSD-007RCO		443134 343047	96445041
						96207647
						96225885
LEGANZA V100	FRT	LH	KSD-008FLO		634096	96207646
						96225884
						96225897
		KSD-008FLG	334212	96332016		
				96342801		
				96207647		
	RH	KSD-008FRO		634095	96225885	
					96225898	
					96243986	
		KSD-008FRG	334212	96332017		
				96342802		
				96207662		
	RR	LH	KSD-008RLO		634098	96225886
						96244006
						96244008
		KSD-008RLG	334214	96342821		
				96213435		
				96225887		
RH	KSD-008RRO		634097	96243990		
				96225887		
				96243990		
KSD-008RRG	334213	96342822				

DAEWOO/GM/CHEVROLET

COMPATIBLE NO LIST

MODEL	FRT/RR	LH/RH/L/R	KIC	KYBI GAS	KYBI OIL	OE NO
LACETTI J200	FRT	LH	KSD-005FLG	339030		96394571
						96399105
						96407819
						96409541
						96425338
						96425340
		KSD-005FLG	96454496			
			96455624			
			96551719			
			96561721			
			96394572			
			96399106			
	RH	KSD-005FRG		339029	96407820	
					96409542	
					96425339	
					96425341	
					96454497	
					96455625	
		KSD-005FRG	96551720			
			96561722			
			96810039			
			96394591			
			96399107			
			96407821			
RR	LH	KSD-005RLG	333420	96408640		
				96409543		
				96425342		
				96425344		
				96455626		
				96462896		
	KSD-005RLO	96810038				
		96403101				
		96394592				
		96399108				
		96407822				
		96408641				
RH	KSD-005RRG		333419	96409544		
				96425343		
				96425345		
				96455627		
				96462897		
				96403102		
LACETTI J300	FRT	LH	KSD-006FLG	339382	13279325	
					13279327	
					13279331	
					13329593	
					13329595	
					13329597	
	KSD-006FLG	13331986				
		13331988				
		13337807				
		13402938				
		13279326				
		13279328				
	RH	KSD-006FRG		339381	13279332	
					13329594	
					13329596	
					13329598	
					13331987	
					13331989	
KSD-006FRG	13402939					
	13279251					
	13279263					
	13329528					
	13332639					
	13402952					
RR	L/R	KSD-006RCG	348032	13412146		

DAEWOO/GM/CHEVROLET

COMPATIBLE NO LIST

MODEL	FRT/RR	LH/RH/L/R	KIC	KYBI GAS	KYBI OIL	OE NO		
MATIZ 1 M100	FRT	LH	KSD-011FLO		632117 332101	96316745		
						96318056		
						96512804		
	RR	L/R	KSD-011RCO		443301 343304	96316781		
						96316746		
						96318057		
MATIZ 2 M150	FRT	LH	KSD-019FLO		332131	96336487		
						96336489		
						96336488		
	RR	L/R	KSD-019RCO		443301 343304	96342033		
						96336490		
						96336488		
MATIZ 2 M150	FRT	LH	KSD-019FLO			96336487		
						96336489		
						96336488		
	RR	L/R	KSD-019RCO		443301 343304	96342033		
						96336490		
						96336488		
MATIZ 3 M200	FRT	LH	KSD-012FLG	332505		96424025		
						96424401		
						96467016		
		RH	KSD-012FRG	332504		96467018		
						96424026		
						96424402		
	RR	L/R	KSD-012RCG	343478		95299742		
						96424027		
						96591241		
		MAGNUS V200 L4	FRT	KSD-010FLO				96334643
								96337533
								96386571
KSD-010FLG						96386573		
						96388872		
						96328573		
RR	KSD-010FRO					96334644		
						96337534		
						96386572		
	KSD-010FRG					96386574		
						96388873		
						96328538		
MAGNUS V200 L6	FRT	LH	KSD-009FLG			96481640		
						96481641		
						96488813		
	RR	L/R	KSD-010RCO			96481641		
						96488817		
						96491663		
REZZO U100	FRT	LH	KSD-009FRG			96491665		
						96488814		
						96488818		
	RR	L/R	KSD-009RLG			96491664		
						96491666		
						96348097		
REZZO U100	FRT	RH	KSD-009RRG			96348440		
						96430904		
						96491675		
	RR	L/R	KSD-009RRG			96430905		
						96499250		
						96499253		

DAEWOO/GM/CHEVROLET

COMPATIBLE NO LIST

MODEL	FRT/RR	LH/RH/L/R	KIC	KYBI GAS	KYBI OIL	OE NO	
NUBIRA J100	FRT	LH	KSD-013FLO		334210	96249294	
						96249296	
						96249302	
						96253926	
						96253930	
						96253932	
		RH	KSD-013FRO			334209	96289801
							96289803
							96300113
							96491211
							96491213
							96491214
	RR	L/R	KSD-013RLO			333255	96491223
							96491225
							96491227
							96491229
							96491250
							96491252
		RH	KSD-013RRO			333254	96491254
							96249295
							96249297
							96249303
							96253927
							96253931
FRT	LH	KSD-014FCO				96253933	
						96289802	
						96289804	
	RH	KSD-014FCG					96300114
							96491212
							96491215
RR	L/R	KSD-014RCO				96491224	
						96491226	
						96491228	
	RH	KSD-014RCG					96491230
							96491251
							96491255
PRINCE	FRT	L/R	KSD-014RCO			96289901	
						96289907	
						96297200	
	RR	L/R	KSD-014RCG				96300279
							98289907
							96289902
REZZO U100	FRT	LH	KSD-015FLO			96289908	
						96297201	
						96300280	
	RR	L/R	KSD-015FRO				98289908
							96147015
							96175440
REZZO U100	FRT	RH	KSD-015RCG	553339		96209901	
						96219034	
						96176115	
	RR	L/R	KSD-015RCG	553339			96209902
							96219036
							96139905
REZZO U100	FRT	LH	KSD-015RCG	553339		96175442	
						96219038	
						96162658	
	RR	L/R	KSD-015RCG	553339			96176116
							96219040
							96286840
REZZO U100	FRT	RH	KSD-015RCG	553339		96286842	
						96343157	
						96399291	
	RR	L/R	KSD-015RCG	553339			96286841
							96286843
							96343158
REZZO U100	FRT	LH	KSD-015RCG	553339		96399292	
						96261066	
						96261066	

DAEWOO/GM/CHEVROLET

COMPATIBLE NO LIST

MODEL	FRT/RR	LH/RH/L/R	KIC	KYBI GAS	KYBI OIL	OE NO			
SPARK M300	FRT	LH	KSD-020FLG			54025462			
						95025460			
						95032443			
						95032445			
						95032447			
		95325958							
		96071861							
		96682475							
		95025461							
		95032444							
	RR	RH	KSD-020FRG			95032446			
						95032448			
						95325959			
						96032446			
						96071862			
		L/R				KSD-020RCG	348036	94579195	
								95026518	
								95026519	
								95259950	
								95325940	
95967519									
95967520									
95967521									
TICO SCAR	FRT	LH	KSD-016FLO		632094			4160278B00	
								41602A78B01	
						41602A78B02			
						41602A78B10			
						41602M70F00			
	RR	RH				KSD-016FRO		632093	4160178B00
									41601A78B01
									41601A78B02
									41601A78B10
									41601M70F00
L/R	KSD-016RCO		342020	41800A78B00					
				41800A78B10					
				41800A78B20					
				41800A78B30					
				41800A78BX0					
TOSCA V250				FRT	LH	KSD-017FLG			96639829
									96639837
									96639835
									96639830
									96639838
	RR	RH	KSD-017FRG						96639836
									96639685
									96639689
									96639686
									96639690
EPICA V250	FRT	LH				KSD-018FLG	339791		96943771
									96943779
									96433771
									96943772
									96943780
	RR	RH	KSD-018FRG	339790					96433772
									96943781
									96943787
									96943782
									96943788
LH	KSD-018RLG	341737						96943781	
								96943787	
								96943782	
								96943788	
								96943788	
RH			KSD-018RRG	341731					96943781
									96943787
									96943782
									96943788
									96943788

DAEWOO/GM/CHEVROLET

COMPATIBLE NO LIST

MODEL	FRT/RR	LH/RH/L/R	KIC	KYBI GAS	KYBI OIL	OE NO
WINSTORM C100	FRT	LH	KSD-021FLG			25983392
						95948809
						96626301
						96858475
						25983393
	RR	RH	KSD-021FRG			95948810
						96626302
						96858476
						25995943
						96626214
CAPTIVA C140	FRT	L/R	KSD-021RCG	345084		96626215
						96626452
						96819164
						96863972
						95147607
WINSTORM C105 MAX	FRT	LH	KSD-022FLG			95147607
						95166266
						95147608
						95166267
						9594M811
WINSTORM C105 MAX	FRT	RH	KSD-022FRG			96858479
						95948812
						96858480
						96858480
						96858480

RENAULT SAMSUNG

COMPATIBLE NO LIST

MODEL	FRT/RR	LH/RH/L/R	KIC	KYBI GAS	KYBI OIL	OE NO
SM3 N17	FRT	LH	KFR-001FLG			4421031030 4421031700
		RH	KFR-001FRG			4422031030 4422031700
	RR	L/R	KFR-001RCG			4531031020 4531031700
		FRT	L/R	KFR-005FCG		543020034R
		RR	L/R	KFR-005RCG		562102543R
SM5 KPQ	FRT	LH	KFR-002FLG			4421151520
		RH	KFR-002FRG			4422151520
SM5 EX1	FRT	LH	KFR-003FLG			4421052700
		RH	KFR-003FRG			4422052700
	RR	L/R	KFR-003RCG			4531052700
SM7 EX2	FRT	LH	KFR-004FLG			4421052010
		RH	KFR-004FRG			4422052010
	RR	L/R	KFR-004RCG			4531052010 4531052130

SSANGYONG

COMPATIBLE NO LIST

MODEL	FRT/RR	LH/RH/L/R	KIC	KYBI GAS	KYBI OIL	OE NO	
ISTANA	FRT	L/R	KSS-004FCO			6613203730	
	RR	L/R	KSS-004RCO			6613263300	
KORANDO KJ	FRT	L/R	KSS-001FCG			4430105400	
						4430106000	
	RR	L/R	KSS-001RCG			4430106220	
						4430106400	
						4431006220	
MUSO FJ	FRT	L/R	KSS-002FCO			4530105400	
						4530106000	
			KSS-002FCG			344309	4530106220
						4530106400	
						4531006220	
	RR	L/R	KSS-002RCO			4430105000	
						4430105002	
			KSS-002RCG			344310	4430105003
						4431005210	
						4430105203	
MUSO P100 SPORTS	FRT	L/R	KSS-003FCG			4430105204	
	RR	L/R	KSS-003RCG			4530105000 4530105002 4530105003 4531005210 4530105203 4530105204 4530105205 4430107201 4431007210 4530107201 4531007210	

TOYOTA_LEXUS

COMPATIBLE NO LIST

MODEL	FRT/RR	LH/RH/L/R	KIC	KYBI GAS	KYBI OIL	OE NO				
AURION CSV40 06-MY	RT	LH	KJT-008FLG	39111		4852006451				
						4852009G40				
						4852006450				
						4852006460				
						4852009G41				
						4852009G80				
	RH	KJT-008FRG	339110		4851009N91					
					4851006450					
					4851006451					
					4851006460					
					4851009N40					
					4851009P30					
	RR	LH	KJT-008RLG	339113		4854006361				
						4854006360				
						4854009610				
						4854009690				
						4854009691				
						4853006360				
RH	KJT-008RRG	339112		4853006361						
				4853009610						
				4853009L30						
				4853009L31						
				4853009Q30						
				4852058120						
ALPHARD GGH20	FRT	LH	KJT-029FLG	335051		4852059505				
		RH	KJT-029FRG	335050		4851058120				
	RR	L/R	KJT-029RCG	349002		4851080416				
						4853080472				
						4853080475				
						4853058060				
COROLLA AE100 92-MY	FRT	LH	KJT-003FLG	333115		4852012610				
						4852012630				
						4852012640				
						4852012700				
						4852012710				
						4852012740				
						4852012860				
						4852019145				
						4852012610D				
						4852012630M				
						4852012640B				
						4852012640C				
						4852012710D				
						4852012740B				
						RH	KJT-003FRG	333114		4851002051
										4851002071
										4851012750
										4851012760
4851012820										
4851012830										
4851012840				4851012870						
				4851019425						
				4851012750M						
				4851012760B						
				4851012760C						
				485101A100						
485101A100F										

TOYOTA_LEXUS

COMPATIBLE NO LIST

MODEL	FRT/RR	LH/RH/L/R	KIC	KYBI GAS	KYBI OIL	OE NO						
COROLLA AE100 92-MY	RR	LH	KJT-003RLG	333117		4854002120						
						4854012510						
						4854012520						
						4854012720						
						4854012730						
						4854012830						
						4854012890						
						4854019095						
						4854019185						
						4854019205						
						4854019265						
						485401A020						
						485401A120						
						485401A170						
						COROLLA ZZE121 01-MY	FRT	LH	KJT-011FLG	333339 B3233(TOKIKO)		4853002130
												4853012570
												4853012580
												4853012770
4853012790												
4853012810												
RH	KJT-003RRG	333116		4853019645								
				4853080003								
				4853090009								
				485301A010								
				485301A180								
				485301A230								
RR	L/R	KJT-011RCG	341307 U2980(TOKIKO)		4852002140							
					4852009430							
					4852002160							
					4851009530							
					4851002140							
					4851002160							
COROLLA ZRE141 07-MY	FRT	LH	KJT-010FLG	339176 339301		4853002170						
		RH	KJT-010FRG	339175 339300		4853080512						
	RR	L/R	KJT-010RCG	341448 340018		4853002190						
						4853009430						
						4853002460						
						4852009P10						
COROLLA NZE121 00-MY	FRT	LH	KJT-004FLG	334324		4852002750						
						4851009W10						
						4851002750						
						4853002680						
						4853002560						
						4853002790						
						4853002660						
						4853002820						
						4852002150						
						4852002360						
						4852009440						
						4852019676						
						4852019706						
						4852019725						
						4852019875						
						RH	KJT-004FRG	334323		4852019885		
										4852019895		
										4852029595		
485202B320												
4852080001												
4852080002												
4851002150				4851002250								
				4851009540								
				485102B320								
				4851080016								
				4851080019								
				4851080026								
4851080029				4851080030								
				4851080058								
				4851080091								
				4851080095								
				4851080095								
				4851080095								

TOYOTA_LEXUS

COMPATIBLE NO LIST

MODEL	FRT/RR	LH/RH/L/R	KIC	KYBI GAS	KYBI OIL	OE NO	
COROLLA NZE121 00-MY	RR	L/R	KJT-004RCG	341322		4853002180	
						4853002480	
						4853013060	
						4853019635	
						4853080029	
						4853080031	
						4853080033	
						4853080046	
						4853080048	
						4853080050	
						4853080052	
						4853080092	
						4853080094	
						4853080096	
						4853080147	
						4853012A40	
						4853012A60	
						4853012B20	
						485301A400	
						485301A420	
						485301A440	
						485301A480	
						485301A620	
485301A640							
485301A650							
48530557N							
COROLLA ZRE152 09-MY	FRT	LH	KJT-019FLG	339701 339067		4852012A41	
		RH	KJT-019FRG	339700 339066		4852002380	
COROLLA CE140 09-MY	RR	L/R	KJT-022RCG	341363		4851012B41	
						4851002380	
						4853012D90	
						4853047040	
						4853002600	
						4853002600C	
						4853002650	
						4853002650B	
						4853002690	
						4853002700	
						4853002770	
						4853080442	
						COROLLA NZE171 14-MY	FRT
4852002B90							
4852002B91							
4852002C01							
4852002C10							
4852002C50							
4852002C70							
4852002C71							
RR	RH	KJT-035FRG	40041		4851002B90		
					4851002B91		
					4851002C00A		
					4851002C01		
					4851002C10		
					4851002C51		
					4851002C71		
	4851002C90						
	RR	L/R	KJT-035RCG	341448			4853002680
							4853002C50
4853002C50A							
4853002C51							
4853002C60A							
4853002C61							
4853002C70A							
4853002C71							
4853002C80A							
4853002C81							

TOYOTA_LEXUS

COMPATIBLE NO LIST

MODEL	FRT/RR	LH/RH/L/R	KIC	KYBI GAS	KYBI OIL	OE NO				
COROLLA NZE173 15-MY	FRT	LH	KJT-040FLG	3340042		485208Z020				
		RH	KJT-040FRG	3340042		4852002B90				
CROWN S180	FRT	LH	KJT-018FLG			485108Z172				
		RH	KJT-018FRG			4851002B90				
	RR	L/R	KJT-018RCG			4852030251				
CRESSIDA RC80	RR	L/R	KJT-030RCG	341111		4852080278				
						4851030801				
						4851080556				
						4853030510				
						4853080471				
CAMRY ACV40 06-MY	FRT	LH	KJT-013FLG	339024		4853022043				
						RH	KJT-013FRG	339024	4853022043	
		RR	LH	KJT-013RLG			4853022091			
							RH	KJT-013RRG		4853029066
										4853029165
CAMRY XV50 11-MY	FRT	LH	KJT-009FLG	339354		4852009D50				
						RH	KJT-009FRG	339353	4852009D60	
									4852009D50	
		RR	LH	KJT-009RLG	339360		4852009W30			
										485108Z035
										485108Z039
									4851006760	
									4851006790	
									4854006600	
									4854006610	
	CAMRY AVV50 11-MY	FRT	LH	KJT-037FLG	339352		4854006611			
										4854006620
										4853006660
									4853006660B	
									4853006670	
RR			RH	KJT-037FRG	339351		4853006710			
										4853009U50
										4853009U60
										4853009V70
										4852033650
CAMRY AVV50 11-MY	FRT	LH	KJT-037RLG	339026		4852033640				
									4852006710A	
									4852033650	
									4852033640	
									4852006710	
	RR	RH	KJT-037RRG	339025		4852006710A				
									4854033460	
									4854006330	
									4854006330C	
									4854006490	

TOYOTA_LEXUS

COMPATIBLE NO LIST

MODEL	FRT/RR	LH/RH/L/R	KIC	KYBI GAS	KYBI OIL	OE NO	
ESTIMA TCR11	FRT	LH	KJT-005FLG	334094		4852029025 4852028020	
		RH	KJT-005FRG	334093		4852029025 4852028020	
	RR	L/R	KJT-005RCG	344225		4853180655 4853128350	
						4853180661	
						4831228340	
ESTIMA TCR10	RR	L/R	KJT-006RCG	344226	NSF2084		
HIACE KDH200V	FRT	L/R	KJT-001FCG	344493		4851180101 4851180107	
						NSF2085	
	RR	L/R	KJT-001RCG	344204		4853180736 4853126390	
						4851126241	
HIACE LH154 VAN	FRT	L/R	KJT-041FCG	344203		4851129526	
						4851129527	
						4851180055	
						4851126212	
HIACE LH166 4WD	FRT	L/R	KJT-025FCG	349037		4851129715	
						4851126200	
						4851129607	
						4851180059	
	RR	L/R	KJT-025RCG	344204			4853126860
							4853180736
							4853126430
							4853126390
GRAND HIACE KCH10W	FRT	L/R	KJT-002FCG			NSF2027X	
	RR	L/R	KJT-002RCG			NSF2033	
HILUX KUN25 05-MY	FRT	L/R	KJT-012FCG			485100KG00	
HILUX LN145 98-MY	FRT	L/R	KJT-023FCG	443214		4851139687	
HILUX GGN15-VIGO	FRT	LH	KJT-026FLG	341398		4852009C60 4852009J70	
		RH	KJT-026FRG	341397		4851009C60 4851009Y90	
	RR	L/R	KJT-028RCG	349015		4853109440 E2979	
						485310K100	
HARRIER MHU38W	FRT	LH	KJT-014FLG			4852048150 4852080015	
		RH	KJT-014FRG			4851048150 4851049835	
		RR	LH	KJT-014RLG			4854048270 4854049595
			RH	KJT-014RRG			4853048270 4853049595
	HARRIER MCU35 07-MY	RR	LH	KJT-014RLG-17.1	339213		4854048281
			RH	KJT-014RRG-17.1	339212		4853048281
	HARRIER ACU30 2WD	RR	LH	KJT-036RLGLH			4854048120
			RH	KJT-036RRGRH			4853048120
HARRIER MCU30	FRT	LH	KJT-021FLG	334400		4852049545 4852049565	
		RH	KJT-021FRG	334399		4851048071 4851048110	
						4851049435	
						4851049455	
						4854049145	
	RR	LH	KJT-021RLG	334395		4854049225	
		RH	KJT-021RRG	334394		4853049215 4853048100	

TOYOTA_LEXUS

COMPATIBLE NO LIST

MODEL	FRT/RR	LH/RH/L/R	KIC	KYBI GAS	KYBI OIL	OE NO	
HIGH LANDER MHU48	FRT	LH	KJT-032FLG	339231		4852048250	
		RH	KJT-032FRG	339230		4851048250	
	RR	LH	KJT-032RLG	339235		4854048370	
		RH	KJT-032RRG	339234		4853048370	
LAND CRUISER KZJ90 PRADO	FRT	L/R	KJT-031FCG	341232		4851069065	
						4851060040	
						4851060060	
						4851060070	
						4851069085	
						4851069086	
PRIUS NHW20 04-MY	FRT	LH	KJT-016FLG	333389		4851069095	
						4852047040	
						4852047041	
						4852047050	
						4852048575	
	RR	L/R	KJT-016RRG	333388			4852049585
							4852080064
							4851047041
							4851047040
							4851047050
PRIUS ZVW30 09-MY	FRT	RH	KJT-016FRG	339242		4851049495	
						4851049505	
						4851049665	
						4851080274	
						4853047031	
	RR	/R	KJT-017-RCG	349035			4853047030
							4853049385
							4853049695
							4852047181
							4852047090
RAV4 XA30	FRT	LH	KJT-017FLG	339243		4852047110	
		RH	KJT-017FRG	339242		4852080228	
	RR	L/R	KJT-015RCG	349024		4851047181	
						4851047090	
SAI AZK10	FRT	LH	KJT-038FLG	3350041		4851047110	
						4585180488	
						4853047091	
						4853080499	
						4853080533	
	RR	L/R	KJT-038RCG	3440093			4852080341
							4851080638
							4853142130
							4852075010
							4852075070
SAI AZK10	FRT	RH	KJT-038FRG	3350040		4852075140	
						4852079045	
						4852079405	
						4851079010	
						4851075070	
	RR	L/R	KJT-038RCG	3440093			4851075140
							4851079042
							4851079395
							4853075020
							4853075020A
SAI AZK10	RR	L/R	KJT-038RCG	3440093		4853075070	
						4853075080	
						4853075090	
						4853074100	
						4853045160	
SAI AZK10	RR	L/R	KJT-038RCG	3440093		4853079255	

TOYOTA_LEXUS

COMPATIBLE NO LIST

MODEL	FRT/RR	LH/RH/L/R	KIC	KYBI GAS	KYBI OIL	OE NO					
WINDOM MCV21	FRT	LH	KJT-007FLG	339087		4852039405					
						4852033250					
						4852033280					
						4852039166					
						4852039255					
						48520AA020					
						4852039365					
						4852039375					
						48520A9020					
						48520A9010					
						48520AA010					
						4852033370					
						4851033250					
						4851033280					
						4851039486					
	RR	RH	KJT-007FRG	339086		4851039615					
						4851039815					
						4851039825					
						48510A9010					
						48510A9020					
						48510AA010					
						48510AA020					
						4851080013					
						4854033090					
						4854033160					
						4854039155					
						4854039195					
						4854039225					
						4854039236					
						4854039246					
						4854039295					
						4854039355					
						4854039375					
RR	RH	KJT-007RRG	334478		4853006081						
					4853006091						
					4853006170						
					4853007080						
					4853009070						
					4853033090						
					4853033160						
					4853033190						
					4853039205						
					4853038205						
					4853039245						
					4853039275						
					IS GXE10	FRT	L/R	KJT-033FCG	341262		4851053010
											4851053020
											4851053030
4851053040											
4851059315											
4851059325											
4851080004											
4851080005											

TOYOTA_LEXUS

COMPATIBLE NO LIST

MODEL	FRT/RR	LH/RH/L/R	KIC	KYBI GAS	KYBI OIL	OE NO
RX450 AL10	FRT	LH	KJT-020FLG	339282		1A13023-B
						1A13592F
						1A13594F
						1A15617F
						4852080208
						48520A9500
						4852080209
						48520A9520
						4852080303
						1A13023-A
	RR	RH	KJT-020FRG	339281		1A13592E
						1A13594E
						1A15617E
						4851080467
						48510A9800
						4851080468
						4851080471
						48510A9820
						4851080583
						1A13588E
						1A13717E
RR	L/R	KJT-020RCG	349203		4853148110	
					4853148200	

NISSAN

COMPATIBLE NO LIST

MODEL	FRT/RR	LH/RH/L/R	KIC	KYBI GAS	KYBI OIL	OE NO
ALMERA N15 98-MY	FRT	LH	KJN-005FLG	332117		543034M426
		RH	KJN-005FRG	332116		543024M426
	RR	L/R	KJN-005RCG	341279		562104M426
DATSUN D40T	FRT	L/R	KJN-006FCG	U3814		56110EB70B
						E6110EB70B
LIVINA L10Z GENISS	FRT	LH	KJN-007FLG	333391		54303CJ40C
		RH	KJN-007FRG	333390		54302CJ41C
MAXIMA A33	FRT	LH	KJN-004FLG	334367		543032Y905
						543032Y987
						543032Y988
						543032Y989
						543036Y300
						543036Y325
						543036Y400
						543036Y425
						543022Y904
						543022Y987
						543022Y988
						543022Y989
	RR	L/R	KJN-004RCG	341341		543026Y300
						543026Y325
						543026Y400
						543026Y425
						562102Y403
						562105Y000
						562105Y025
						562106Y000
						562106Y300
						562106Y325
						562106Y401
						562106Y425
NAVARA GD21 2WD	FRT	L/R	KJN-008FCO	443238		5611025G00
						5611025G25
						5611025G26
						5611025G27
	RR	L/R	KJN-008RCO	443226		5611025G50
						5611025G85
						5621025G00
						5621025G25
SUNNY N16 00-MY	LH		KJN-001FLG	333311		543036N100
						543036N125
						543036N1X5
						543036N200
						543036N225
						543036N2X5
						54303BM418
						54303BM485
	RH		KJN-001FRG	333310		54303BN424
						543026N100
						543026N125
						543026N1X5
						543026N200
						543026N225
						543026N2X5
						54302BM418
54302BN421						
54302BN424						
54302BN425						
54302BN428						

NISSAN

COMPATIBLE NO LIST

MODEL	FRT/RR	LH/RH/L/R	KIC	KYBI GAS	KYBI OIL	OE NO
SUNNY N16	RR	L/R	KJN-001RCG	341279		562104M400
						562104M405
						562104M425
						562104M426
						562104Z000
						562104Z005
						562104Z025
						562104Z027
						562104Z600
						562104Z625
						562105M400
						562105M425
						562108M400
						562108M600
TIIDA C11	FRT	LH	KJN-002FLG	B2323(TOKIKO)		E4C03EE90A
						E4303EE90A
						54303ED001
		RH	KJN-002FRG	B2322(TOKIKO)		E4303CJ41C
						E4C02EE90A
						E4302EE90A
VERSA C12	FRT	LH	KJN-003FLG	332153		54303AN0C
		RH	KJN-003FRG	332152		E43023AN0C
	RR	L/R	KJN-003RCG	348029		543023AN0C
						562101HJ1A
						E62103AN0C

SUZUKI

COMPATIBLE NO LIST

MODEL	FRT/RR	LH/RH/L/R	KIC	KYBI GAS	KYBI OIL	OE NO
ALTO HA11	FRT	LH	KJS-002FLG			NST8006L
		RH	KJS-002FRG			NST8006R
CAPPUCCINO EA11	FRT	L/R	KJS-002RCG			NSG8006A
	RR	L/R	KJS-003FCG			NSF9027
SWIFT FZ82	FRT	LH	KJS-004FLG	338095		4160258M00
						4160258M20
						4160271L00
		RH	KJS-004FRG	338094		4160271L20
						4160158M00
						4160158M20
	RR	L/R	KJS-004RCG	384084		4160171L00
						4160171L20
						4181058M00
						4181058M20
						4181070L01
						4181071L00
SWIFT RS413	FRT	LH	KJS-005FLG	333426		4160263J10
						4160263J11
						4160263J12
		RH	KJS-005FRG	333425		4106877J10
						4106877J20
						4160163J10
	RR	L/R	KJS-005RCG	343464		4160163J11
						4160163J12
						4180063J00
						4180063J01
						4180063J02
						4181063J00
WAGON R C11	FRT	LH	KJS-001FLG			NST5180L
		RH	KJS-001FRG			NST5180R
	RR	L/R	KJS-001RCG			NSF1031

MITSUBISHI

COMPATIBLE NO LIST

MODEL	FRT/RR	LH/RH/L/R	KIC	KYBI GAS	KYBI OIL	OE NO
LANCER CB2A KRESTALA	FRT	LH	KJMI-003FLG	333289		MR316070
		RH	KJMI-003FRG	333288		SW604189
	RR	L/R	KJMI-003RCG	341145		SW604063
						MR316069
LANCER CS9A ESTATE	FRT	L/R	KJMI-005FCG	334420		SW604062
						30618110
						MB891463
						MB891464
						SW604061
						4060A320
	RR	L/R	KJMI-005RCG	341368		MN101957
						MR589639
						4162A184
						MN100077
						MN100090
						MN101601
LANCER CY2A C9	FRT	LH	KJMI-007FLG	339118		4060A242
	RR	L/R	KJMI-007RCG	341444		4060A241
L200 L021P	FRT	L/R	KJMI-009FCG	443189		4162A036
L200 KA5T	FRT	L/R	KJMI-004FCG	340033	5510002	4162A130
						MB109561
						MR992321
						MR992320
OUTLANDER CW5W	FRT	LH	KJMI-006FLG	339081		4062A031
	RR	L/R	KJMI-006RCG	349040		4062A082
PAJERO V64W	FRT	L/R	KJMI-008FCG	341445		4062A099
						4060A173
						4060A174
						4162A050
						4062A002
						4062A003
	RR	L/R	KJMI-008RCG	344300		4062A005
						4062A006
						4062A023
						4062A024
						MR418049
						MR554291
MR554330						
						MR566275
						MR566276
						4162A016
						4162A023

MODEL	FRT/RR	LH/RH/L/R	KIC	KYBI GAS	KYBI OIL	OE NO
MAZDA2 DE DEMIO	FRT	LH	KJM-001FLG	333495		DR61-34-900B
		RH	KJM-001FRG	333494		DR61-34-700B
	RR	L/R	KJM-001RCG	553379		D04A-28-70XE
MAZDA3 BK SPEED	FRT	LH	KJM-002FLG	334701		B37F-34-900
						B37F-34-900A
						B37F-34-900B
						BRY0-34-900
						B37F-34-700
	RH	KJM-002FRG	334700		B37F-34-700A	
					B37F-34-700B	
					BRY0-34-700	
					BBN5-28-910C	
					BRY0-28-910	
RR	L/R	KJM-002RCG	343412		BHP7-34-900	
					B45L-34-900	
MAZDA3 BM 14-MY	FRT	LH	KJM-003FLG	3340036		B54G-34-900
						B60P-34-900
						B60P-34-900A
						BHS2-34-900
						BHS2-34-900A
						BHP7-34-700
						B45L-34-700
						B54G-34-700
						B60P-34-700
						B60P-34-700A
	RH	KJM-003FRG	3340035		BHS2-34-700	
					BHS2-34-700A	
					BHN2-28-700A	
					BHN2-28-910B	
					BHN9-28-700A	
					BJM5-28-910A	
					BJT6-28-700D	
					BKC6-28-910A	
					BKC6-28-910B	
					B45L-28-910A	
RR	L/R	KJM-003RCG	3430041		B60P-28-700A	
					B60P-28-910B	
					GJR9-34-900	
					GJR9-34-900B	
					GJR9-34-900C	
					GJR9-34-900D	
					GJR9-34-700	
					GJR9-34-700B	
					GJR9-34-700C	
					GJR9-34-700D	
MAZDA6 GJ 12-MY	FRT	LH	KJM-004FLG	339405		GJR9-28-700B
						GJR9-28-700C
						GJR9-28-700D
						GJR9-28-700E
						BR70-34-900D
	RH	KJM-004FRG	339404		BR70-34-900	
					B4553-34-900D	
					B459-34-900D	
					BR70-34-700D	
					BR70-34-700	
RR	L/R	KJM-004RCG	349246		B4553-34-700D	
					B459-34-700D	
					BR70-28-900A	
					BB1P-28-900A	
					BR70-28-700D	
MAZDA 323 BG 89-MY	FRT	LH	KJM-006FLO	333127	633138	BR70-28-700D
						BR70-34-900
						B4553-34-900D
						B459-34-900D
	RH	KJM-006FRO	333126	633137		BR70-34-700D
						BR70-34-700
						B4553-34-700D
						B459-34-700D
RR	LH	KJM-006RLG	333133	633144	BR70-28-900A	
					BB1P-28-900A	
	RH	KJM-006RRG	333132	633143		BR70-28-700D
						BB1P-28-700A

MODEL	FRT/RR	LH/RH/L/R	KIC	KYBI GAS	KYBI OIL	OE NO
MAZDA 323 BJ 98-MY	FRT	LH	KJM-007FLG	333275		B26R-34-900
						B25D-34-900C
						B25T-34-900C
	RH	KJM-007FRG	333274		B3D-34-900C	
					BK2H-34-900A	
					B26R-34-700	
RR	LH	KJM-007RLG	333296		B25D-34-700C	
					B25T-34-700C	
					BK2H-34-700A	
MAZDA 323 BJ 00-MY	FRT	LH	KJM-008FLG	333351		BK2J-28-700E
						BK2J-28-900E
						B30D-34-900C
	RH	KJM-008FRG	333350		B25T-34-900D	
					B26R-34-900D	
					B26R-34-900E	
MAZDA 626 CAPELLA GF	FRT	LH	KJM-009FLG	334200		B30D-34-700C
						B25T-34-700D
						B26R-34-700D
	RH	KJM-009FRG	334199		B26R-34-700E	
					BJ3D-34-700E	
					GE6V-34-900	
RR	LH	KJM-009RLG	334202		G14F-34-900A	
					GE4V-34-900A	
					GE4T-28-900A	
RH	KJM-009RRG	334201		GE4V-28-900A		
				GE4T-28-700A		
				GE4V-28-700A		
MAZDA PREMACY CP	FRT	LH	KJM-005FLG	333269		C100-34-900B
		RH	KJM-005FRG	333268		C100-34-900
						C100-34-700B
						C100-34-700

ISUZU

COMPATIBLE NO LIST

MODEL	FRT/RR	LH/RH/L/R	KIC	KYBI GAS	KYBI OIL	OE NO
DMAX RA 4WD	FRT	L/R	KJI-001FCG	340107		8979470973
						8979470983
						8979470994
						8981619152

CHERY

COMPATIBLE NO LIST

MODEL	FRT/RR	LH/RH/L/R	KIC	KYBI GAS	KYBI OIL	OE NO
CHERY A5	FRT	L/R	KCC-001FCG			2905010
						A21-2905010
CHERY A113	FRT	L/R	KCC-002FCG			S12-2905010
	RR	L/R	KCC-002RCO			S12-2915010
CHERY TIGGO	FRT	LH	KCC-003FLG			T11-2905010
		RH	KCC-003FRG			T11-2905020
	RR	L/R	KCC-003RCG			T11-2915010

BYD

COMPATIBLE NO LIST

MODEL	FRT/RR	LH/RH/L/R	KIC	KYBI GAS	KYBI OIL	OE NO
BYD F3	FRT	LH	KCB-001FLG	334324		F3-2905010
		RH	KCB-001FRG	334323		F3-2905020
	RR	L/R	KCB-001RCG	341322		F3-2915010

GEELY

COMPATIBLE NO LIST

MODEL	FRT/RR	LH/RH/L/R	KIC	KYBI GAS	KYBI OIL	OE NO
EMGRAND EC7	FRT	LH	KGG-001FLG			1064001256
		RH	KGG-001FRG			1064001257
	RR	L/R	KGG-001RCG			1064001268

FIAT

COMPATIBLE NO LIST

MODEL	FRT/RR	LH/RH/L/R	KIC	KYBI GAS	KYBI OIL	OE NO
FIAT 127	FRT	L/R	KIF-001FCO			1762 4383008
	RR	L/R	KIF-001RCO			594712 4256650
FIAT 128	FRT	L/R	KIF-002FCO			594719 4408215
	RR	L/R	KIF-002RCO			594713 4408218
FIAT 131	FRT	L/R	KIF-003FCO			11501 4418700
FIAT 132	FRT	L/R	KIF-004FCO		443013	293329 4325450
	RR	L/R	KIF-004RCO			294631 4285686

CHRYSLER

COMPATIBLE NO LIST

MODEL	FRT/RR	LH/RH/L/R	KIC	KYBI GAS	KYBI OIL	OE NO
CHRYSLER 300 LX	FRT	LH	KUCH-001FLG			68072065AE
		RH	68072064AE			

OPEL

COMPATIBLE NO LIST

MODEL	FRT/RR	LH/RH/L/R	KIC	KYBI GAS	KYBI OIL	OE NO
ASTRA T91	FRT	L/R	KGO-001FCO		365504	32A710
						A-8102H
						90236798
	RR	L/R	KGO-001RCO		343099	90443129
						27D56A
						A-1706H
ASTRA T98	RR	L/R	KGO-002RCO		43307	90272379
CORSA S83	FRT		KGO-003FCO		323034	A-1258G
						93172195
	RR		KGO-003RCO			A-3602H
VECTRA J89	FRT		KGO-004FCO		365503	90009929
						A-1603H
						90166772
						115007
						90236796
						A-8734G

PEUGEOT

COMPATIBLE NO LIST

MODEL	FRT/RR	LH/RH/L/R	KIC	KYBI GAS	KYBI OIL	OE NO
PEUGEOT 206	FRT	LH	KFP-001FLG	333730		M5202AX
	RR	RH	KFP-001FRG	333729		5202AY
	RR	L/R	KFP-001RCG	341249		5206Q4
PEUGEOT 405	FRT	L/R	KFP-002FCG	333829		520204
	RR	L/R	KFP-002RCO	341102		520665

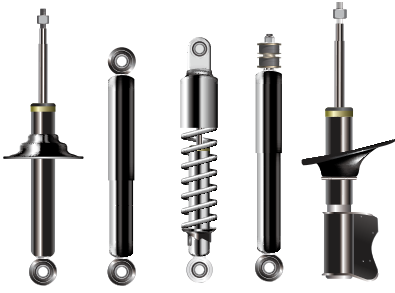

Strategic partnerships with global partners in the global automotive parts after market continue to expand

- Suspension link and body-chassis connection
- Secure ride and handling performance
- Ensure a smooth ride and improving driving stability
- Excellent ride feeling & Roll stability



28, MTV.4-RO 48 BEON-GIL,DANWON-GU, ANSAN-SI, GYEONGGI-DO, 15658, KOREA
TEL. +82-31-432-4081 | FAX. +82-31-624-4086
OVERSEAS. sales01@kicoltd.co.kr | LOCAL. sales@kicoltd.co.kr

www.kicoltd.co.kr